

**Poulan®**  
**3400 Counter-Vibe®**  
**CHAIN SAW**  
**OPERATOR'S MANUAL**

**⚠ WARNING:**

Carefully read and follow Safety Rules, Precautions and Operating Instructions. Failure to do so can result in serious personal injury.

**Beird-Poulan Division**  
Emerson Electric Co.  
Shreveport, Louisiana

# TABLE OF CONTENTS

Specifications .....	2	B. Tree Felling Techniques .....	12
<b>SPECIAL SAFETY SECTION</b> .....	3, 4 & 5	C. Bucking .....	13
<b>Know Your Chain Saw</b> .....	6	D. Debranching and Pruning .....	14
<b>Preparing Your Saw For Use</b> .....	7	<b>Maintenance</b> .....	15
A. Getting Ready .....	7	A. Guide Bar and Chain .....	16
B. Attaching The Spur .....	7	B. Ignition and Exhaust Systems .....	17
C. Attaching The Bar and Chain .....	7	C. Starter Rope Repair and Replacement .....	18
D. Chain Tension .....	8	D. Clutch and Drum/Sprocket .....	19
E. Engine Fuel Mixture .....	9	E. Carburetor Adjustments .....	20
F. Bar and Chain Oil .....	10	F. Air Filter .....	21
<b>Using Your Saw</b> .....	10	G. Counter-Vibe® Anti-Vibration System .....	21
A. Control Devices .....	10	H. Storage .....	21
B. Starting Instructions .....	11	I. Trouble Shooting Chart .....	22
<b>Types of Cutting</b> .....	11	J. Maintenance Chart .....	23
A. Basic Cutting Technique .....	11	<b>Parts List</b> .....	24
		<b>Parts &amp; Service</b> .....	Back Cover

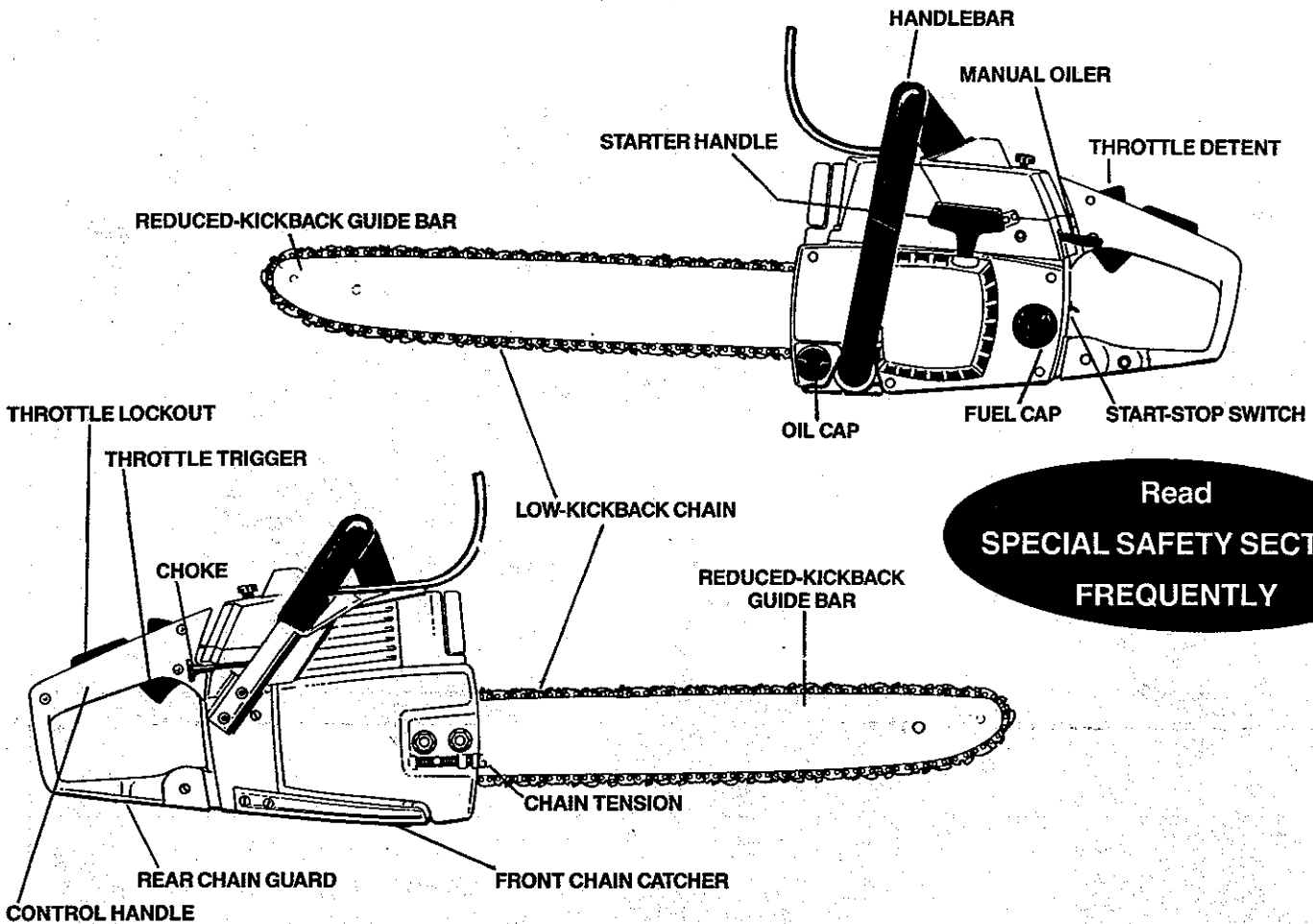

## SPECIFICATIONS

MODEL	3400 Counter Vibe*	IGNITION	Solid State
CU. IN. DISPLACEMENT	3.4 cu. in./56 cu. cm.	MODULE AIR GAP	.008 to .014
GUIDE BAR— SPROCKET NOSE	16", 18", 20" Control Tip*	FUEL MIX	Gasoline/Oil Mixture (see p. 9)
GUARD LINK CHAIN	3/8 Pitch .050 Gauge Chrome Cutters - P72S	MUFFLER	Spark Arresting/Temperature Limiting
SPARK PLUG	Champion CJ-8Y	OILER SYSTEM	Automatic/Manual Override
SPARK PLUG GAP	.023 to .027	FUEL TANK CAPACITY	19 oz. 562 cu. cm.
		OIL TANK CAPACITY	12 oz. 355 cu. cm.

# SPECIAL SAFETY SECTION

## GUARD AGAINST KICKBACK

Kickback is a dangerous reaction that can lead to serious personal injury. *Do not rely only on the safety devices provided with your saw. As a chain saw user, you must take special safety precautions to help keep your cutting jobs free from accident or injury.*

### KICKBACK WARNING

Kickback can occur when the moving chain contacts an object at the upper portion of the tip of the guide bar or when the wood closes in and pinches the saw chain in the cut. *Contact at the upper portion of the tip of the guide bar can cause the chain to dig into the object and stop the chain for an instant. The result is a lightning fast, reverse reaction which kicks the guide bar up and back toward the operator. If the saw chain is pinched along the top of the guide bar, the guide bar can be driven rapidly back toward the operator. Either of these reactions can cause loss of saw control which can result in serious personal injury.*

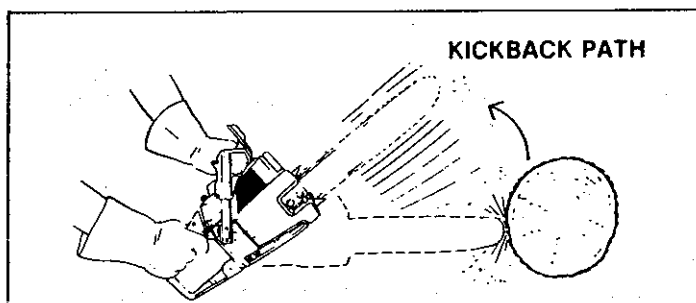

Figure 1

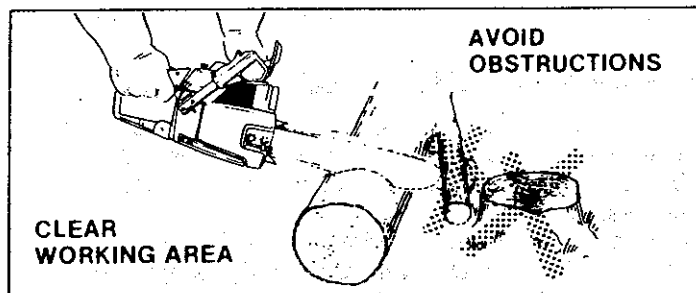

Figure 2

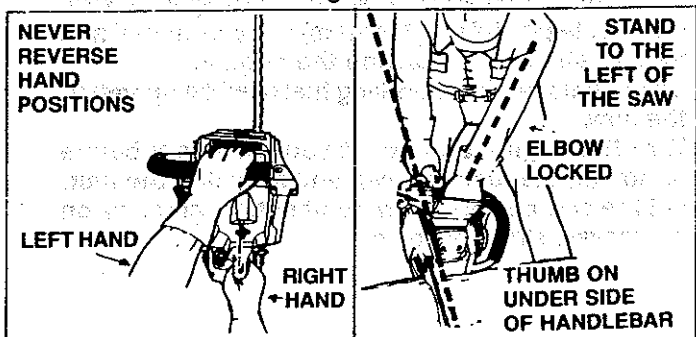

Figure 3

## REDUCE THE CHANCE OF KICKBACK

1. Recognize that kickback can happen. With a basic understanding of kickback, you can reduce the element of surprise which contributes to accidents.
2. Never let the moving chain contact any object at the tip of the guide bar. Figure 1.
3. Keep the working area free from obstructions such as other trees, branches, rocks, fences, stumps, etc. Figure 2. Eliminate or avoid any obstruction that your saw chain could hit while you are cutting through a particular log or branch.
4. Keep your saw chain sharp and properly tensioned. Follow manufacturer's chain sharpening and maintenance instructions. Check tension at regular intervals with the engine stopped, never with the engine running. Make sure the bar clamp nuts are securely tightened after tensioning the chain. A loose or dull chain can increase the chance of kickback to occur.
5. Begin and continue cutting at full throttle. If the chain is moving at a slower speed, there is greater chance for kickback to occur.
6. Cut one log at a time.
7. Use extreme caution when re-entering a previous cut.
8. Do not attempt plunge cuts.
9. Watch for shifting logs or other forces that could close a cut and pinch or fall into the chain.
10. Use the Reduced-Kickback Guide Bar and Low-Kickback Chain specified for your saw.

## MAINTAIN CONTROL

1. Keep a good firm grip on the saw with both hands when the engine is running and don't let go. Figure 3. A firm grip can neutralize kickback and help you maintain control of the saw. Keep the fingers of your left hand encircling and your left thumb under the front handlebar. Keep your right hand completely around the rear handle *whether you are right handed or left handed*. Keep your left arm straight with the elbow locked.
2. Position your left hand on the front handlebar so it is in a straight line with your right hand on the rear handle when making bucking cuts. Figure 3. Never reverse right and left hand positions for any type of cutting.
3. Stand with your weight evenly balanced on both feet.
4. Stand slightly to the left side of the saw, to keep your body from being in a direct line with the cutting chain. Figure 3.
5. Do not overreach. You could be drawn or thrown off balance and lose control of the saw.
6. Do not cut above shoulder height. It is difficult to maintain control of the saw above shoulder height.

# SPECIAL SAFETY SECTION (continued)

## WARNING

Because a chain saw is a high-speed wood-cutting tool, special safety precautions must be observed to reduce the risk of personal accidents. Careless or improper use can cause serious personal injury.

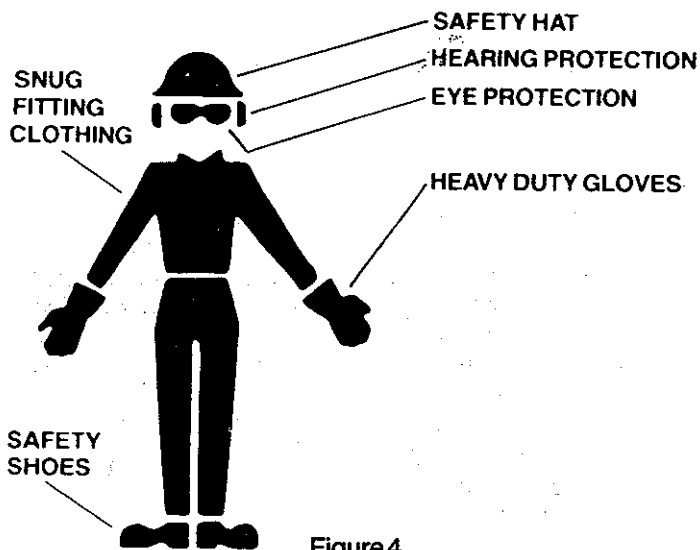

Figure 4

## KNOW YOUR SAW

1. Read your Operator's Manual carefully until you completely understand and can follow all safety rules and operating instructions before attempting to operate the unit.
2. Restrict the use of your saw to adult users who understand and follow the safety rules, precautions, and operating instructions found in this manual.

## PLAN AHEAD

1. Wear personal protective gear. Figure 4. Always use steel-toed safety footwear with non-slip soles; snug-fitting clothing; heavy-duty non-slip gloves; eye protection such as non-fogging, vented goggles or face screen; an approved safety hard hat, and sound barriers — ear plugs or muffs to protect your hearing. Regular users should have hearing checked regularly as chain saw noise can damage hearing.
2. Keep children, bystanders, and animals out of the work area — a minimum of 30 feet (10 meters). Do not allow other people or animals to be near the chain saw when starting or operating the chain saw.
3. Do not handle or operate a chain saw when you are fatigued, ill, or upset; or if you have taken alcohol, drugs or medication. You must be in good physical condition and mentally alert. Chain saw work is strenuous. If you have any condition that might be aggravated by strenuous work, check with your doctor before operating a chain saw.

4. Do not attempt to use your chain saw during bad weather conditions such as strong wind, rain, snow, etc., or at night.
5. Plan your sawing operation carefully in advance. Do not start cutting until you have a clear work area, secure footing, and if you are felling trees, a planned retreat path.

## AVOID REACTIVE FORCES

Pinch-Kickback and Pull-in occur when the chain is suddenly stopped by being pinched, caught, or by contacting a foreign object in the wood. This results in a reversal of the chain force used to cut wood and causes the saw to move in the opposite direction of chain rotation. *Pinch-Kickback drives the saw straight back toward the operator. Pull-in pulls the saw away from the operator.* Either reactions can result in loss of control and possible serious personal injury.

To avoid Pinch-Kickback:

1. Be extremely aware of situations or obstructions that can cause material to pinch the top of or otherwise stop the chain.
2. Do not cut more than one log at a time.
3. Do not twist the saw as the bar is withdrawn from an under-cut when bucking.

To avoid Pull-in:

1. Always begin cutting with the engine at full throttle and the saw frame or spur against the wood.
2. Use wedges made of plastic or wood, (never of metal) to hold the cut open.

## HANDLE FUEL WITH CAUTION

1. Eliminate all sources of sparks or flame in the areas where fuel is mixed, poured, or stored. There should be no smoking, open flames, or work that could cause sparks.
2. Mix and pour fuel in an outdoor area, on bare ground; store fuel in a cool, dry, well-ventilated place; and use an approved, marked container for all fuel purposes.
3. Wipe up all spilled fuel before starting your saw.
4. Move at least 10 feet (3 meters) away from fuel and fueling site before starting the engine.
5. Do not smoke while handling fuel or while operating the saw.
6. Turn the engine off and let your saw cool before removing the fuel tank cap and refueling the unit.
7. Let the saw cool in a non-combustible area, not on dry leaves, straw, paper, etc.

## **OPERATE YOUR SAW SAFELY**

1. Do not operate a chain saw that is damaged, improperly adjusted, or not completely and securely assembled.
2. Operate the chain saw only in outdoor areas.
3. Do not operate the saw from a ladder or in a tree.
4. Position all parts of your body to the left of cut and away from the saw chain when the engine is running.
5. Cut wood only. Do not use your saw to pry or shove away limbs, roots or other objects.
6. Make sure the chain will not make contact with any object while starting the engine. Never try to start the saw when the guide bar is in a cut or kerf.
7. Use extreme caution when cutting small size brush and saplings. Slender material can catch the saw chain and be whipped toward you or pull you off balance.
8. Be alert for springback when cutting a limb that is under tension so you will not be struck by the limb or saw when the tension in the wood fibers is released.
9. Do not put pressure on the saw at the end of a cut. This can cause you to lose control when the cut is completed.
10. Stop the engine before setting the saw down.

## **MAINTAIN YOUR SAW IN GOOD WORKING ORDER**

1. Have all chain saw service performed by a qualified service dealer with the exception of the items listed in the maintenance section of this manual. For example, if improper tools are used to remove or hold the flywheel when servicing the clutch, structural damage to the flywheel can occur and cause the flywheel to burst.
2. Keep fuel and oil caps, screws and fasteners securely tightened.
3. Keep the handles dry, clean, and free of oil or fuel mixture.
4. Make certain the saw chain stops moving when the throttle trigger is released. For correction, refer to page 20 for carburetor idle adjustment instructions.
5. Stop the saw if the chain strikes a foreign object. Inspect the unit and repair or replace parts as necessary.
6. Disconnect the spark plug before performing any maintenance except for carburetor adjustments.
7. Never modify your saw in any way. Use only attachments supplied or specifically recommended by the manufacturer.
8. Always replace the handguard immediately if it becomes damaged, or broken or is otherwise removed.

## **CARRY AND STORE YOUR SAW SAFELY**

1. Hand carry the unit with the engine stopped, the Muffler away from your body, and the Guide Bar and Chain to the rear covered preferably with a scabbard.
2. Before transporting in any vehicle or storing in any enclosure, allow your saw to cool completely, cover the bar and chain and properly secure to avoid turnover, fuel spillage or damage.
3. Drain oil and fuel tank before storing for more than 30 days.
4. Store in a dry area out of the reach of children and away from where fuel vapors can reach sparks or an open flame from hot water heaters, furnaces, etc.

**NOTE:** Exposure to vibrations through prolonged use of chain saws may produce Whitefinger disease (Raynaud's phenomenon). This phenomenon reduces the hand's ability to feel and regulate temperature, produces numbness and burning sensations and can cause nerve and circulation damage and tissue necrosis.

An anti-vibration system designed to reduce engine vibration is recommended for those using chain saws on a regular or sustained basis. An anti-vibration system does not guarantee the avoidance of Whitefinger disease. Continual and regular users must monitor closely their use of chain saws and physical condition.

**Notice:** Refer to the Code of Federal Regulations, Section 1910.266(5); 2.5.1 of American National Standard Safety Requirements for Pulpwood Logging, ANSI 03.1-1978; and relevant state safety codes when using a chain saw for logging purposes.

## **SAVE THESE INSTRUCTIONS**

# KNOW YOUR CHAIN SAW

## A. INTRODUCTION

- Your saw has been designed with safety in mind and includes the following features as standard equipment:
  - Reduced-Kickback Guide Bar (Contfol Tip®)
  - Low-Kickback Chain (Elongated Guard Link)
  - Spark Arrestor
  - Temperature Limiting Muffler
  - Handguards
  - Temperature Limiting Muffler
  - Counter-Vibe® Anti-Vibration System

### ⚠ WARNING

The following features are included on your saw to help reduce the hazard of kickback, however, such features will not totally eliminate this dangerous reaction. As a chain saw user, do not rely only on safety devices. You must follow all safety precautions, instructions and maintenance in this manual to help avoid kickback and other forces which can result in serious personal injury.

## B. KICKBACK SAFETY FEATURES

- **Reduced-Kickback Guide Bar**, designed with a small radius tip which reduces the size of the kickback danger zone on the bar tip. Figure 5. A Reduced Kickback Guide Bar is one which has been demonstrated to significantly reduce the number and seriousness of kickbacks when tested in accordance with the safety requirements for gasoline powered chain saws as set by the American National Standards Institute, Inc., Standard B175.1 - 1985.
- **Low-Kickback Chain**, designed with a contoured depth gauge and guard link which deflect the kickback force and allow wood to gradually ride into the cutter. Figure 5. Low Kickback Saw Chain is chain which has met the kickback performance requirements of ANSI B175.1 (Safety Requirements for Gasoline -Powered Chain Saws) when tested on a representative sample of chain saws below 3.8 cubic inch displacement specified in ANSI B175.1. (American National Standards Institute, Inc., Standard B175.1 - 1985).
- **Handguard**, designed to reduce the chance of your left hand contacting the chain if your hand slips off the front handlebar.
- **Position of front and rear handlebars**, designed with distance between handles and "in line" with each other. The spread and "in line" position of the hands provided by this design work together to give balance and resistance in controlling the pivot of the saw back toward the operator if kickback occurs.

### ⚠ WARNING

Do not operate the chain saw unless the safety devices or their specified replacements are properly installed and maintained according to the instructions in this manual. Do not use any other guide bar and chain combination that is not equivalent to the original equipment or not certified to comply with ANSI B175.1. Failure to follow these instructions can result in serious personal injury.

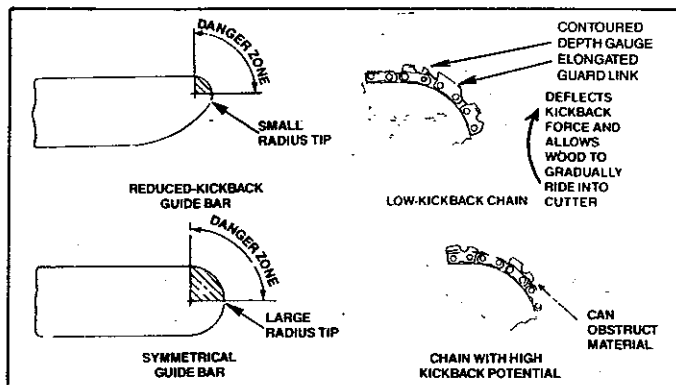

Figure 5

## C. STATE AND LOCAL REQUIREMENTS.

Your saw is equipped with a temperature limiting muffler and spark arresting screen which meets the requirements of California Codes 4442 and 4443. All U.S. forest land and the states of California, Maine, Washington and Oregon require many internal combustion engines to be equipped with a spark arrestor screen by law.

If you operate a chain saw in a state or locale where such regulations exist, you are legally responsible for maintaining the operating condition of these parts. Failure to do so could subject you to liability or to a fine. Muffler and spark arrestor maintenance is found on page 17 & 18.

## D. CARTON CONTENTS

After you unpack the carton:

1. Check the contents against the list below.
2. Examine the items for damage.
3. *Notify your dealer immediately if a part is missing or damaged.*

**NOTE:** A rattle like noise in a powerhead with an empty fuel or oil tank is a normal condition, caused by a filter moving against the wall of an empty tank.

KEY NO. CARTON CONTENTS: QTY.

1	Power Head	1
2	Guide Bar	1
3	*Spur	1
4	*Screw - Spur	2
5	Chain	1
6	Scrench	1
—	Loose Parts Bag (not shown)	1
—	Operator's Manual (not shown)	

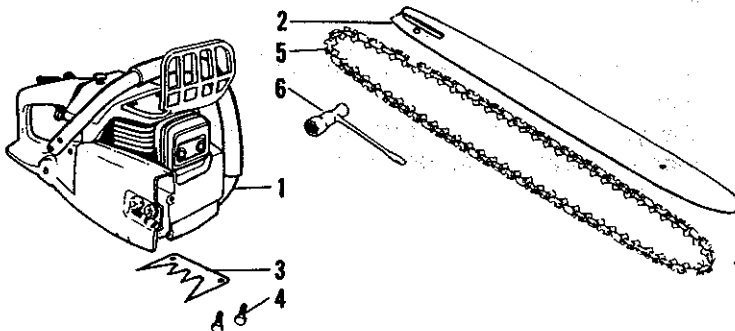

# PREPARING YOUR SAW FOR USE

## A. GETTING READY

### 1. READ YOUR OPERATOR'S MANUAL

Your Operator's Manual has been developed to help you prepare your saw for use and to understand its safe operation. It is important that you read your manual completely to become familiar with the unit *before* you begin assembly or attempt operation. Your Poulan® dealer is available to show you how to operate your saw. Be sure to ask for his assistance.

### 2. HAVE THE FOLLOWING AVAILABLE:

- Protective gloves
- Approved, marked, fuel container.
- One gallon leaded or unleaded, regular gasoline
- 8 oz. (1/2 pt.), 2-cycle, air-cooled engine oil (See page 9).
- Bar and Chain Oil (See page 10.)
- Scrench** — provided with your unit. No other tool is necessary for assembly. Use the long end of the tool as a slotted screwdriver, the small pipe end as a socket wrench, and the larger pipe end to remove the spark plug.

## B. ATTACHING THE SPUR (Standard Equipment on Some Units)

The spur is a special piece of equipment designed to assist the cutting operation. When assembled to the saw, the spur will dig into the tree or log and:

- relieve contact pressure adding ease to the sawing operation.
- allow the saw to be more easily rotated or pivoted into the cut.

#### To Install:

- Remove Bar Clamp Nuts, Bar Clamp and Guide Bar Plates.
- Align the spur over the two holes on the bar clamp side of the saw. Figure 6.
- Insert the two screws and tighten evenly and securely.

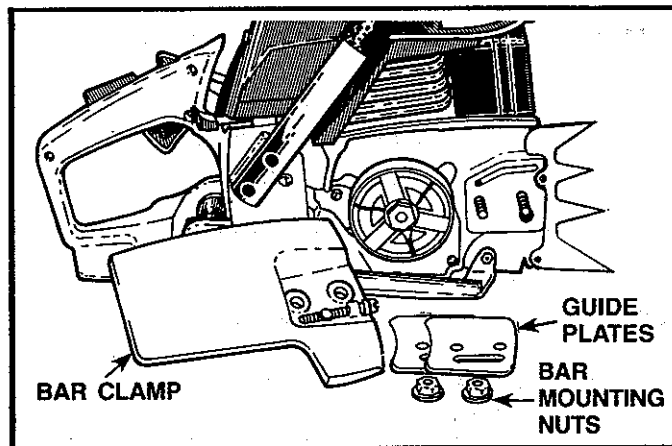

Figure 6

## C. ATTACHING THE BAR AND CHAIN

**CAUTION:** Wear protective gloves when handling or operating your saw. The chain is sharp and can cut you even when it is not moving!

- Your saw is equipped with a Reduced-Kickback Guide Bar and a Low-Kickback Chain.
- Always use the Reduced-Kickback Guide Bar and the Low-Kickback Chain specified for your chain saw model, when replacing these parts.

#### ⚠ WARNING

Do not start engine without guide bar and chain completely assembled. Otherwise, the clutch can come off and serious personal injury can result.

1. Install the Inner Guide Plate over the bar mounting studs. Figure 7.

**NOTE:** Be sure the inner Guide Plate curves or flanges toward the saw frame away from the Guide Bar. Figure 8.

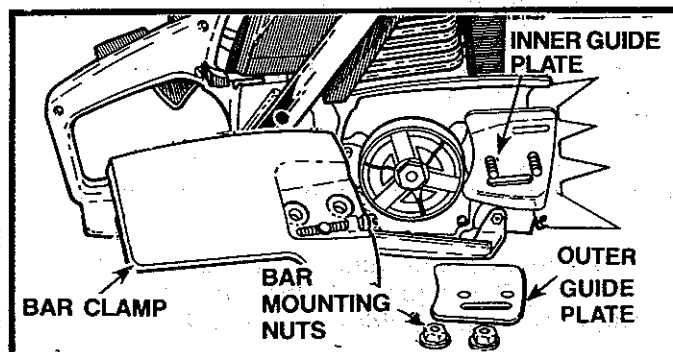

Figure 7

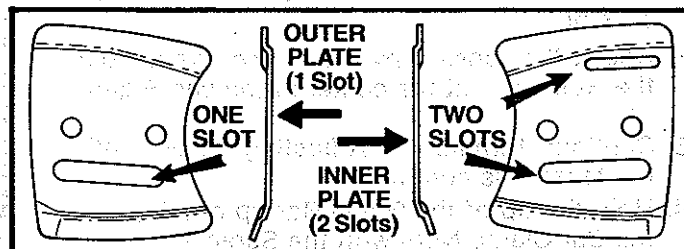

Figure 8

2. Mount the Guide Bar with the slotted end over the bar mounting studs. Figure 9 .

**NOTE:** Be sure the Guide Bar is positioned with the round hole below the large slot.

3. Hold chain with cutters facing as shown in Figure 10.
4. Place chain over and behind the clutch drum onto the sprocket.
5. Slide Guide Bar to the rear of the saw as far as possible.
6. Fit the bottom of the drive links between the teeth in the sprocket.
7. Start at the top of the bar and fit the chain drive links into the groove around the Guide Bar. Figure 10.
8. Pull the Guide Bar forward until the chain is snug in the guide bar groove. Figure 11.
9. Install the outer guide plate. Figure 7 .
10. Slide the Bar Clamp over the mounting studs and fit the bar adjusting pin (Figure 11) into the adjusting pin hole in the Guide Bar. Figure 9.
11. Replace the Bar Mounting Nuts and tighten finger tight *only*.

**NOTE:** The Bar Clamp nuts must be slightly loose to tension the chain correctly.

12. Follow "Chain Tension" instructions below.

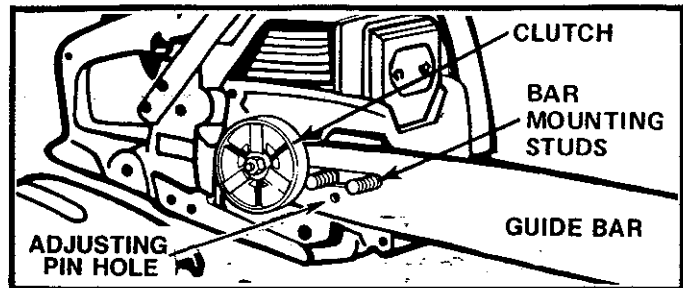

Figure 9

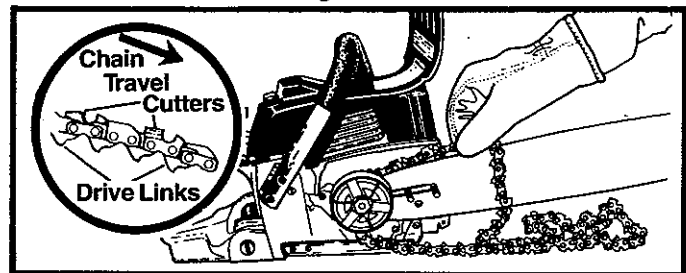

Figure 10

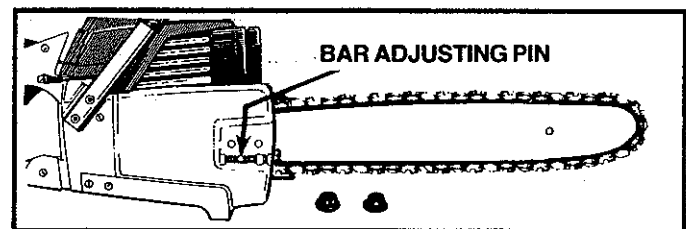

Figure 11

## D. CHAIN TENSION

- **Correct chain tension is very important:**
  - a loose chain will wear the bar and itself.
  - a loose chain can jump off the bar while you are cutting.
  - a tight chain can damage the saw and/or break.
- **Chain tension is correct when the chain:**
  - can be lifted about 1/8" from the Guide Bar at a point near the middle of the bar, and
  - will move freely around the bar.
- **The chain stretches during use, especially when new. Check tension:**
  - each time the saw is used
  - more frequently when the chain is new
  - as the chain warms up to normal operating temperature

1. Hold the tip of the Guide Bar up and turn the Adjusting Screw just until the chain does not sag beneath the Guide Bar. Figure 12.

**NOTE:** Turn screw clockwise to tighten tension. Turn screw counterclockwise to loosen tension.

2. Check the tension by lifting the chain from the Guide Bar at the center of the bar. Figure 13.
3. Continue turning the Adjusting Screw until the tension is correct.
4. Hold the tip of the Guide Bar up and tighten the Bar Clamp Nuts with the Srench.
5. Recheck tension.

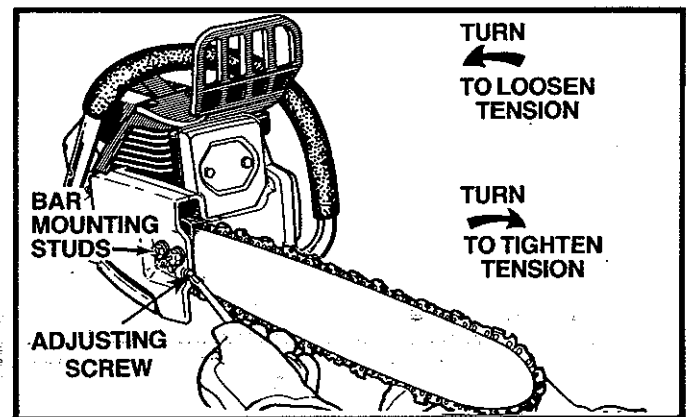

Figure 12

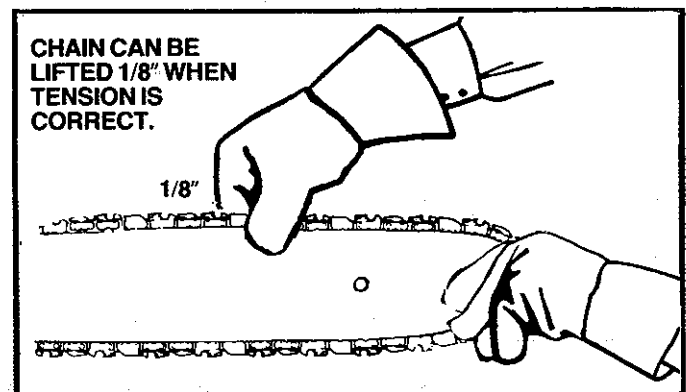

Figure 13



## E. ENGINE FUEL MIXTURE

- Your chain saw is powered by a two-cycle engine which requires a fuel mixture of regular gasoline (leaded or unleaded) and a high quality engine oil specially made for 2-cycle air-cooled engines. The internal design of the 2-cycle engine requires lubrication of moving parts. Lubrication is provided when you use the recommended mixture of gasoline and oil.
- Gasoline must be clean and not over two months old. After a short period of time, gasoline begins to chemically break down and will form compounds that can cause hard starting and damage in 2-cycle engines.
- The correct measure of gasoline to oil is very important.
  - Too much oil in the mixture will foul the spark plug.
  - Too little oil will cause the engine to overheat resulting in damage.
- Mix the fuel thoroughly in a container since gasoline and oil do not readily combine. Do not try to mix fuel directly in the fuel tank.

### 1. DO NOT USE:

- **BIA Oil (Boating Institute of America)** —
  - Does not have proper additives for air-cooled, 2-cycle engines and could cause damage.
- **AUTOMOTIVE OIL** —
  - Does not have proper additives for 2-cycle engines and could cause damage.
- **GASOLINE CONTAINING ALCOHOL** — (High Test, Premium or Gasohol)
  - Stiffens critical carburetor fuel metering elements and causes engine damage from overheating.
  - Increases vaporlock (causes hard starting).
  - Attracts water causing corrosion damage.

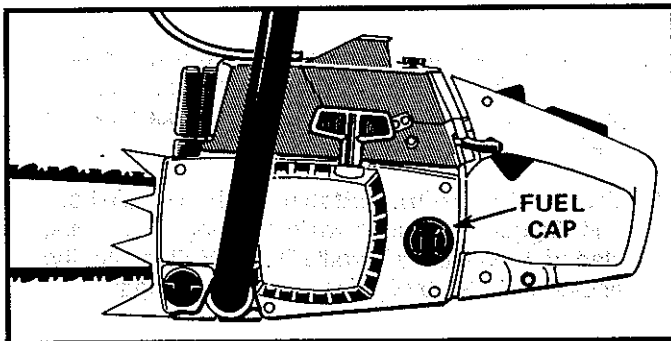
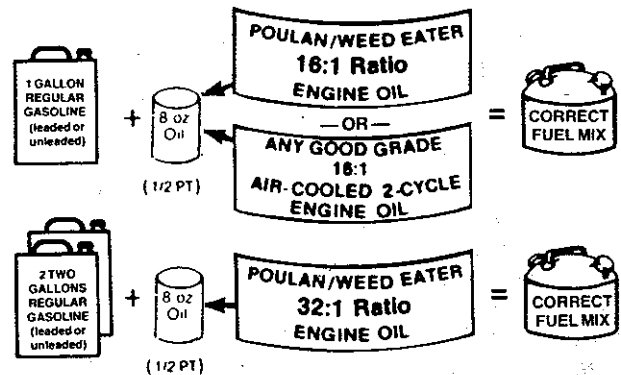

Figure 14

Read  
**SPECIAL SAFETY SECTION**  
FREQUENTLY

### 2. USE THE FOLLOWING:

Two types of Poulan/Weed Eater Engine Oil are available — one blended to be mixed at a 16:1 ratio and the other at a 32:1 ratio.



**CAUTION:** If you use a 32:1 fuel mix, you must use genuine Poulan/Weed Eater 32:1 Engine Oil or engine damage can occur. Do not use a fuel mix leaner than 32:1.

### 3. HOW TO MIX FUEL

- a. Pour one-half of the gasoline into an approved, marked container. Do not try to mix oil and gasoline directly in the fuel tank.
- b. Add entire measure of 2-cycle Engine Oil.
- c. Mix.
- d. Add remainder of gasoline.
- e. Mix thoroughly for one minute.

### 4. IMPORTANT POINTS

- a. Use only recommended fuel mixtures.
- b. Eliminate all sources of sparks or flames in the areas where fuel is mixed, poured, or stored. There should be no smoking, open flames or work that could cause sparks.
- c. Use an approved, marked container for all fuel purposes.
- d. Mix and pour fuel in an outdoor area on bare ground. Store fuel in a cool, dry, well-ventilated place. Gasoline vapors are harmful to your health and can cause serious hazards such as explosion and fire. Use a funnel or spout when pouring fuel.
- e. Avoid over filling the fuel tank. Allow  $\frac{3}{4}$  inch for expansion. Tighten Fuel Cap securely. Figure 14.
- f. Wipe up all fuel spills. Wipe off any fuel spilled on the saw. Completely dry the saw before using.
- g. Move at least 10 feet (3 meters) away from fuel and fueling site before starting the engine.

## F. BAR AND CHAIN OIL

- The Guide Bar and Cutting Chain require continuous lubrication in order to remain in operating condition. Lubrication is provided by the automatic oiler system when the oil tank is kept filled.
  - Lack of oil will quickly ruin the Bar and Chain.
  - Too little oil will cause overheating shown by smoke coming from the chain and/or discoloration of the Guide Bar Rails.
- Genuine Poulan® bar and chain oil is recommended to protect your unit against excessive wear due to heat and friction. Poulan® lubricant resists high temperature thinning. If Poulan® bar and chain lube is not available, use a good grade SAE 30 oil. Never use waste oil for this purpose.
- In freezing weather oil will thicken, making it necessary to thin bar and chain oil with a small amount of Diesel Fuel #1 or Kerosene. Bar and chain oil must be free flowing for the oil system to pump enough oil for adequate lubrication.

### 1. USE THE FOLLOWING:

- 30°F or above — Lubricant — undiluted.  
30°-0°F — 95% lubricant to 5% Diesel Fuel #1 or Kerosene.  
Below 0°F — 90% lubricant to 10% Diesel Fuel #1 or Kerosene.

## 2. HOW TO FILL THE OIL TANK

- a. Stop the engine.
- b. Turn saw on its side with oil cap up. Figure 15.
- c. Loosen cap slowly and wait for pressure in the tank to be released before removing the cap.
- d. Fill the oil tank.
- e. Replace the oil cap securely.

## 3. IMPORTANT POINTS TO REMEMBER

- a. Prime the oil pump on a new saw or a saw that has been unused for an extended period of time. Pump the manual oiler slowly several times. Start the engine and allow the chain to run. Stop the engine and check for an even flow of oil on the chain. Repeat this procedure until oil is visible on the chain.
- b. Fill the oil tank each time you refill the fuel tank to ensure there will be sufficient oil for the chain whenever you start and run the saw.
- c. The saw will use about 1/2 tank of chain oil for each tank of fuel mixture. If less oil is used, check for a plugged oil hole in the guide bar.
- d. It is normal for a small amount of oil to appear under the saw after the engine stops. This is due to oil draining from the bar and chain when not in use.

FILL THE OIL TANK EACH TIME THE FUEL TANK IS FILLED.

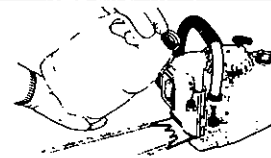

Figure 15

## USING YOUR SAW

### A. CONTROL DEVICES

Understanding the control devices on your saw is an important part of learning how to properly and safely operate the unit. Figure 16.

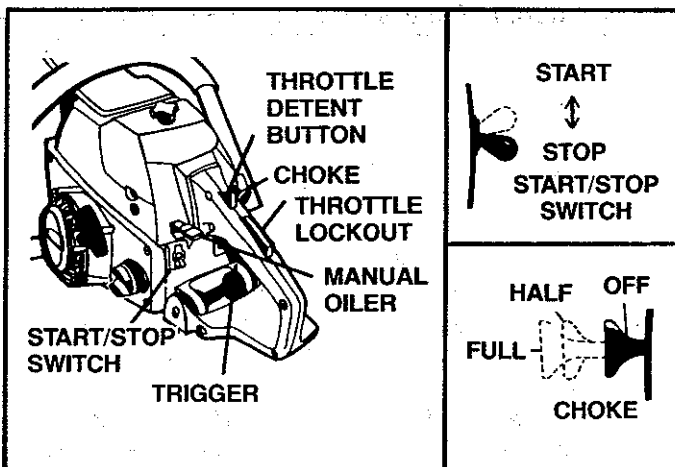

Figure 16

1. The Ignition Switch is a toggle switch which is moved up for the "Start" position and moved down for the "Stop" position.
2. The two-position Choke helps to start the saw by controlling the air flow to the fuel system.
3. The Trigger accelerates and controls the speed of the engine and is designed to be used with the Throttle Lock.
4. The Throttle Lock is a control feature which prevents the Trigger from becoming accidentally engaged. The Throttle Lock must be pressed before the Trigger can be activated.
5. The Throttle Detent Button holds the Throttle Lock and Trigger in position while the engine is being started. Release the Throttle Detent Button after the engine is started by lightly squeezing the trigger.
6. The Manual Oiler is placed to be operated by your right thumb. Use the manual oiler to supplement the automatic oiler:
  - during a long felling cut
  - when cutting into a log or tree which is greater in diameter than the length of the guide bar.
  - anytime an additional supply of oil is desired.

## B. STARTING INSTRUCTIONS

### 1. BASIC PROCEDURE

- Set the saw on flat ground making certain the saw chain is free to turn without contacting any object. Figure 17.
- Move ignition switch to the "Start" position.
- Push down on the throttle lockout, squeeze the trigger, press and hold down the throttle detent button, then slowly release the trigger.
- Adjust choke according to "Starting Procedure for Varying Conditions" below.
- Hold front handlebar with left hand & place right foot through rear handle to stabilize saw.
- Pull starter rope quickly, using no more than 15-18 inches of rope per pull. Using the full length of the starter rope may cause it to break. Do not let the starter rope snap back. Hold the handle and let the rope rewind slowly.
- Release the throttle detent button after engine starts, allowing the engine to idle. *The chain must not move when the engine runs at idle speed.* If correction is required, refer to "Carburetor Adjustments," page 20.
- Stop engine by moving the ignition switch to the "STOP" position (Figure 16).

#### ⚠ WARNING

Always wear gloves; safety footwear; snug-fitting clothing; and eye, hearing, and head protection devices when operating a chain saw.

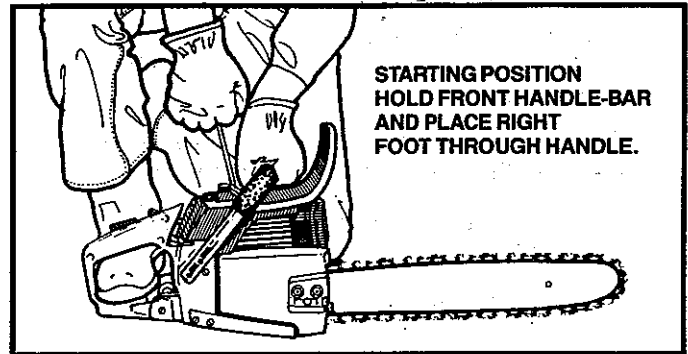

STARTING POSITION  
HOLD FRONT HANDLE-BAR  
AND PLACE RIGHT  
FOOT THROUGH HANDLE.

Figure 17

#### ⚠ WARNING

Avoid bodily contact with the muffler when starting or using a warm engine to avoid serious burns.

### 2. STARTING PROCEDURE FOR VARYING CONDITIONS

CONDITIONS	Move ignition switch to start	Pull choke knob to full choke	Press throttle lockout and squeeze trigger	Press throttle detent button release trigger	Pull starter rope until engine fires	Push choke knob in	Pull starter rope until engine runs	Squeeze trigger to release throttle detent
a. Cold Engine	X	X	X	X	3-5 times	X	X	X
b. Warm Engine	X	choke off	X	X			X	X
c. Refueled Engine after running out of gas	X	X	X	X	3-5 times	X	X	X
d. Flooded Engine	X	choke off	X	X			X	X
e. Cold Weather Starting	X	X	X	X	3-5 times	half choke* (out of cut)	X	X

\*Allow engine to warm-up (1-2 min.) on half-choke, then move choke to the "Off" position. Do not cut with the choke at the "On" or "Half" position. Figure 15.

## TYPES OF CUTTING

### A. BASIC CUTTING TECHNIQUE

#### 1. IMPORTANT POINTS.

- Cut wood only. Do not cut metal, plastics, masonry, non-wood, building materials; etc.
- Stop the saw if the chain strikes a foreign object. Inspect the unit and repair or replace parts as necessary.
- Keep the chain out of dirt and sand. Even a small amount of dirt will quickly dull a chain and thus, increase the possibility of kickback.

#### 2. UNDERSTAND REACTIVE FORCES

Pinch-Kickback and Pull-In occur when the chain is suddenly stopped by being pinched, caught, or by contacting a foreign object in the wood. This results in a reversal of the chain force used to cut wood and causes the saw to move in the opposite direction of chain rotation. Either reaction can result in loss of control and possible serious personal injury.

#### ⚠ KICKBACK WARNING

Kickback can occur when the moving chain contacts an object at the upper portion of the tip of the guide bar or when the wood closes in and pinches the saw chain in the cut. *Contact at the upper portion of the tip of the guide bar can cause the chain to dig into the object and stop the chain for an instant. The result is a lightning fast, reverse reaction which kicks the guide bar up and back toward the operator. If the saw chain is pinched along the top of the guide bar, the guide bar can be driven rapidly back toward the operator.* Either of these reactions can cause loss of saw control which can result in serious personal injury.

##### • Pinch-Kickback

- occurs when the chain, on top of the bar is suddenly stopped when the top of the bar is used for cutting.
- rapidly drives the saw straight back toward the operator.

• **Pull-In** —

— can occur when the chain on the bottom of the bar is suddenly stopped.

— pulls the saw rapidly forward.

**3. PROCEDURE**

Practice cutting a few small logs using the following technique to get the "feel" of using your saw before you begin a major sawing operation.

- a. Accelerate the engine to full throttle just before entering the cut by squeezing the throttle trigger.
- b. Begin cutting with the saw frame or spur against the wood. Figure 18.
- c. Keep the engine at full throttle the entire time you are cutting.
- d. Allow the chain to cut for you; exert only light downward pressure. If you force the cut, damage to the bar, chain, or engine can result.

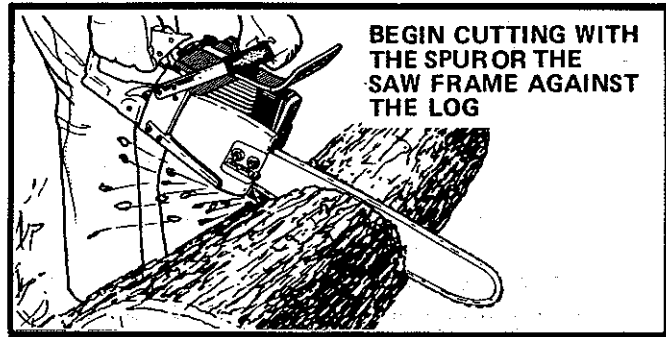

Figure 18

- e. Release the throttle trigger as soon as the cut is completed, allowing the engine to idle. If you run the saw at full throttle without a cutting load, unnecessary wear can occur to the chain, bar, and engine.
- f. Do not put pressure on the saw at the end of the cut to avoid losing control when the cut is complete.
- g. Stop the engine before setting the saw down after cutting.

**B. TREE FELLING TECHNIQUES**

**1. PLAN YOUR SAWING OPERATION CAREFULLY IN ADVANCE**

- a. Clear the work area. You need a clear area all around the tree where you can have secure footing.
- b. Study the natural conditions that can cause the tree to fall in a particular direction:
  - 1.) The **WIND** direction and speed
  - 2.) The **LEAN** of the tree
  - 3.) **WEIGHTED** with **BRANCHES** on one side
  - 4.) Surrounding **TREES** and **OBSTACLES**
- c. Look for decay and rot. If the trunk is rotted, it could snap and fall toward the operator.
- d. Check for broken or dead branches which could fall on you while cutting.
- e. Make sure there is enough room for the tree to fall. Maintaining a distance of 2½ tree lengths from the nearest person or other objects. Engine noise may drown out warning call.
- f. Remove dirt, stones, loose bark, nails, staples, and wire from the tree where cuts are to be made.

- g. Plan to stand on the up-hill side when cutting on a slope.
- h. Plan a clear retreat path to the rear and diagonal to the line of fall. Figure 20.

**2. FELLING SMALL TREES — LESS THAN 6" IN DIAMETER**

- a. If you know the direction of fall:
  - 1.) Make a single felling cut on the side away from the direction of fall.
  - 2.) Cut all the way through.
  - 3.) Stop the saw, put it down, and get away quickly on your planned retreat path.
- b. If you are not sure which way the tree will fall, use the notch method described for felling large trees.

**⚠ WARNING**

**DO NOT CUT:**

- near electrical wires or buildings.
- if you do not know the direction of tree fall.
- at night since you will not be able to see well.
- during bad weather — strong wind, snow, rain, etc.

**DON'T PUT YOURSELF IN THESE POSITIONS**

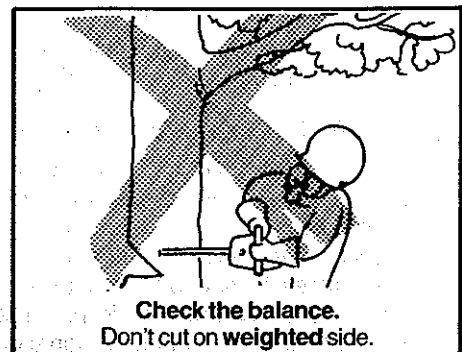
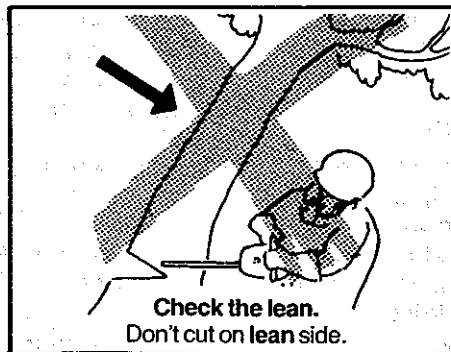
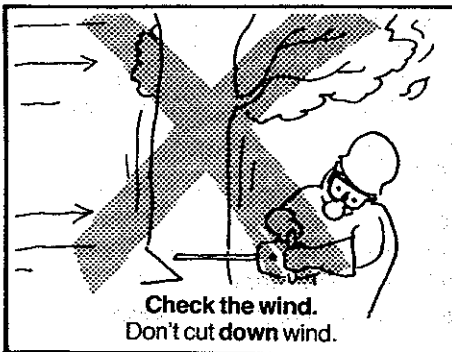

### 3. FELLING LARGE TREES — 6" DIAMETER OR MORE

The notch method is used to cut large trees. A notch is cut on the side of the tree in the desired direction of fall. After a felling cut is made on the opposite side of the tree, the tree will tend to fall into the notch.

**NOTE:** If the tree has large buttress roots, remove before making the notch. Cut into the buttresses vertically, then horizontally. Figure 19

- a. Make the notch cut. Figure 21
  - 1.) Cut the bottom of the notch first, through 1/3 of the diameter of the tree.
  - 2.) Complete the notch by making the slant cut.
  - 3.) Remove the notch of wood.
- b. Make the felling cut on the opposite side of the notch about 2" higher than the bottom of the notch.
- c. Leave enough uncut wood between the felling cut and the notch to form a hinge. Figure 22.

**NOTE:** The hinge helps to keep the tree from twisting and falling in the wrong direction.

- d. Use a wedge if there is any chance that the tree will not fall in the desired direction.

**NOTE:** Before the felling cut is complete, drive wedges to open up the cut when necessary to control the direction of fall. Use wood or plastic wedges but *never* metal, to avoid kickback and chain damage.

- e. Be alert for signs that the tree is ready to fall:
  - 1.) cracking sounds
  - 2.) widening of the felling cut
  - 3.) movement in the upper branches.

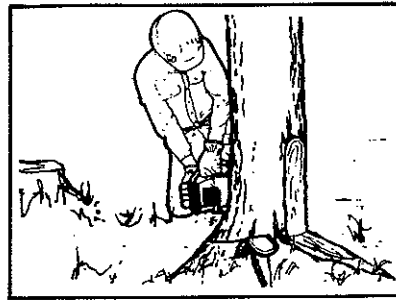

Figure 19

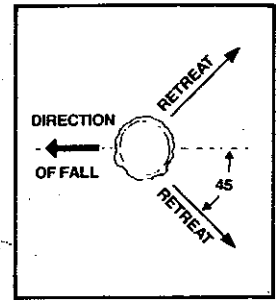

Figure 20

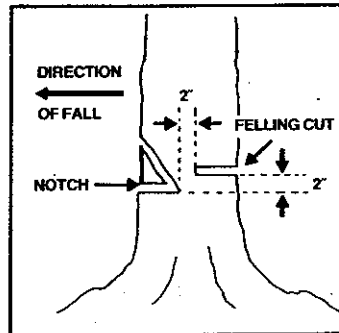

Figure 21

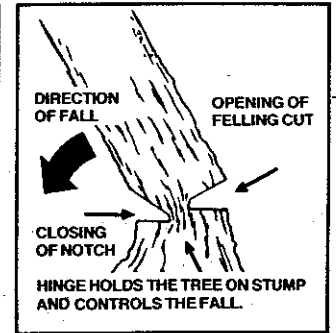

Figure 22

#### WARNING

Stay on the uphill side of the terrain to avoid the tree rolling or sliding downhill after it is felled.

- f. As the tree starts to fall, stop the saw; put it down, and get away quickly on your planned retreat path.
- g. Be extremely cautious with partially fallen trees that may be poorly supported. When a tree doesn't fall completely, set the saw aside and pull down the tree with a cable winch, block and tackle or tractor. Do not cut it down with your saw to avoid injury.

### C. BUCKING

Bucking is the term used for cutting a fallen tree to the desired log size.

#### 1. IMPORTANT POINTS

- a. Cut only one log at a time.
- b. Cut shattered wood very carefully. Sharp pieces of wood could be flung toward the operator.
- c. Use a sawhorse to cut small logs. Never allow another person to hold the log while cutting and never hold the log with your leg or foot.
- d. Give special attention to logs under strain to prevent the saw from pinching. Make the first cut on the pressure side to relieve the stress on the log. Figure 23.
- e. Do not cut in an area where logs, limbs and roots are tangled such as in a blown down area. Drag the logs into a clear area before cutting by pulling out exposed and cleared logs first.

- f. Make the first bucking cut 1/3 of the way through the log and finish with a 2/3 cut on the opposite side. As the log is being cut, it will tend to bend. The saw can become pinched or hung in the log if you make the first cut deeper than 1/3 of the diameter of the log.

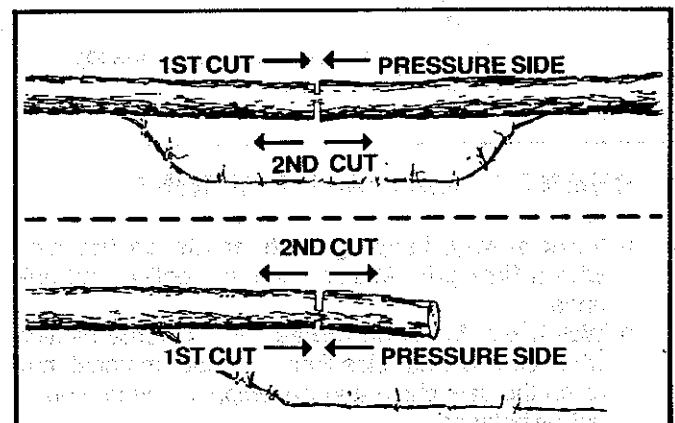

Figure 23

**⚠ WARNING**

Never turn the saw upside down to undercut. The saw cannot be controlled in this position.

**2. TYPES OF CUTTING USED** Figure 24.

—**Overcutting** — begin on the top side of the log with spur or saw frame against the log; exert light pressure downward.

—**Undercutting** — begin on the under side of the log with the top of the saw against the log; exert light pressure upward. During undercutting, the saw will tend to push back at you. Be prepared for this reaction and hold the saw firmly to maintain control.

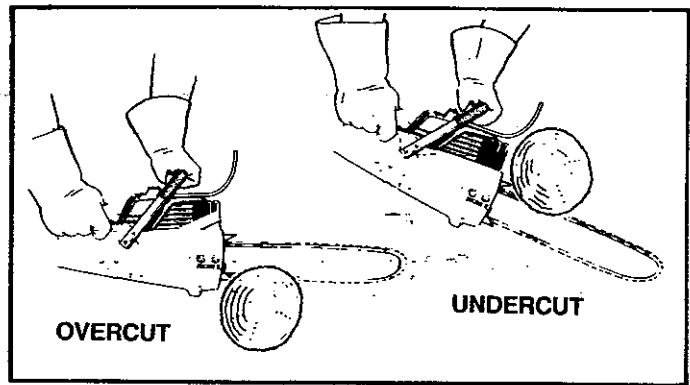

Figure 24

**⚠ WARNING**

If saw becomes pinched or hung in a log, don't try to force it out. You can lose control of the saw resulting in personal injury and/or damage to the saw. Stop the saw, drive a wedge of plastic or wood into the cut until the saw can be removed easily. Figure 25. Restart the saw and carefully reenter the cut. Do not use a metal wedge to avoid kickback and chain damage.

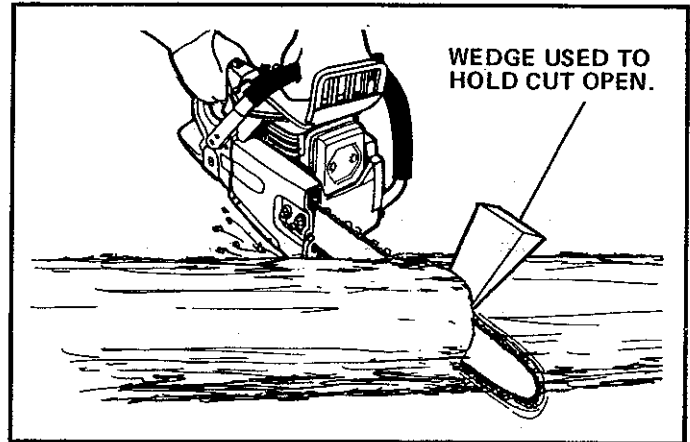

Figure 25

**3. BUCKING — WITHOUT A SUPPORT**

- Overcut with a 1/3 diameter cut.
- Roll log over and finish with an overcut.

**4. BUCKING — USING ANOTHER LOG AS A SUPPORT** Figure 26.

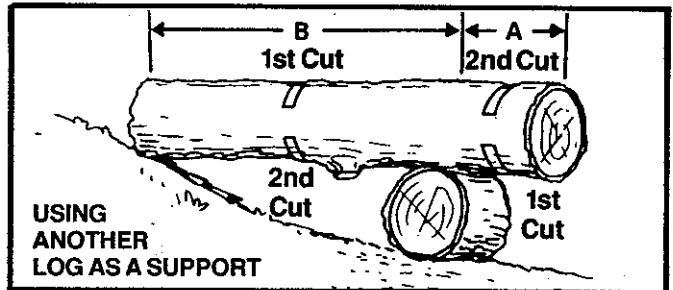

Figure 26

**⚠ WARNING**

Do not stand on the log being cut. The cut portion will roll down hill.

- In area A:
  - Undercut 1/3 of the way through the log.
  - Finish with an overcut.
- In area B:
  - Overcut, 1/3 of the way through the log.
  - Finish with an undercut.

**5. BUCKING — USING A STAND** Figure 27.

- In area A:
  - Undercut 1/3 of the way through the log.
  - Finish with an overcut.
- In area B:
  - Over cut 1/3 of the way through the log.
  - Finish with an undercut.

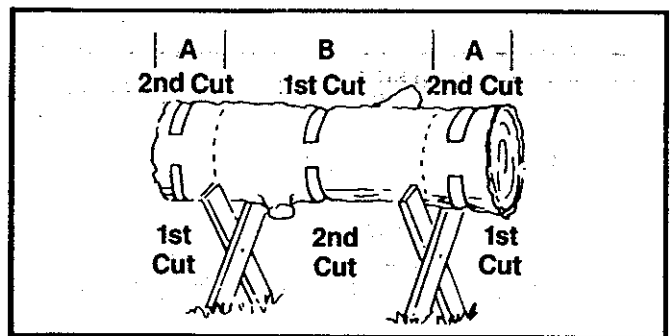

Figure 27

**D. DEBRANCHING AND PRUNING**

- **Work slowly, keeping both hands on the saw with a firm grip.** Maintain secure footing and balance.
- **Watch out for springpoles.** Use extreme caution when cutting small size limbs. Slender material may catch the saw chain and be whipped toward you or pull off balance.
- **Be alert for springback.** Watch out for branches that are bent or under pressure as you are cutting to avoid being struck by the branch or the saw when the tension in the wood fibers is released.
- **Keep a clear work area.** Frequently clear branches out of the way to avoid tripping over them.

**⚠ WARNING**

Never climb into a tree to debranch or prune. Do not stand on ladders, platforms, a log or in any position which can cause you to lose your balance or control of the saw.

**1. DEBRANCHING**

- a. **Always debranch a tree *after* it is cut down.** Only then can debranching be done safely and properly.
- b. **Leave the larger lower limbs to support the tree as you work.**
- c. **Start at the base of the felled tree and work towards the top, cutting branches and limbs.** Remove small limbs with one cut. Figure 28.
- d. **Keep the tree between you and the chain.** Cut from the side of the tree opposite the branch you are cutting.
- e. **Remove larger, supporting branches with the 1/3, 2/3 cutting techniques described in the bucking section.**
  - 1.) Start with an undercut
  - 2.) Finish with an overcut
- f. **Always use an undercut to cut small and freely hanging limbs.** Undercutting could cause limbs to fall and pinch the saw.

**2. PRUNING**

- a. **Limit pruning to limbs shoulder height or below.** Do not cut if branches are higher than your shoulder. Get a professional to do the job.
- b. **Refer to Figure 29 for the pruning technique.**
  - 1.) Undercut 1/3 of the way through the limb near the trunk of the tree.
  - 2.) Finish with an overcut farther out from the trunk.
  - 3.) Keep out of the way of the falling limb.
  - 4.) Cut the stump flush near the trunk of the tree.

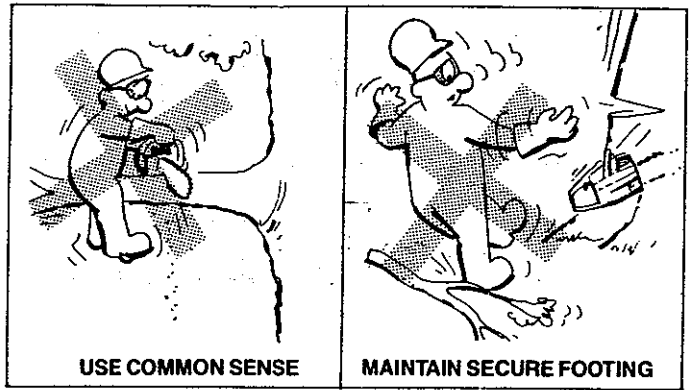

USE COMMON SENSE

MAINTAIN SECURE FOOTING

**⚠ WARNING**

Be alert for and guard against kickback. Do not allow the moving chain to contact any other branches or objects at the nose of the guide bar when debranching or pruning. Allowing such contact can result in serious personal injury.

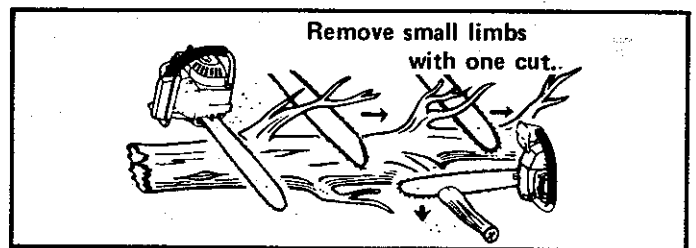

Figure 28

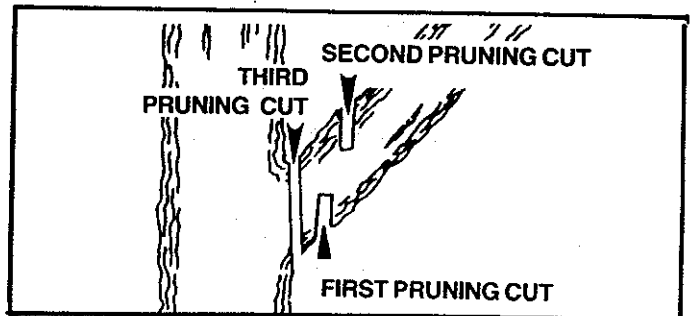

Figure 29

## MAINTENANCE

A good maintenance program of regular inspection and care will increase the service life and help to maintain the safety and performance of your saw.

- **Make all adjustments or repairs (except carburetor adjustments) with:**
  - spark plug wire disconnected
  - engine cool as opposed to a unit that has just been run.
- **Check the saw for loose bolts, screws, nuts and fittings regularly.** Loose fasteners can cause an unsafe condition as well as damage to your saw.

**⚠ WARNING**

Have all chain saw service (other than the items listed in the maintenance section of this manual) performed by a qualified service dealer.

Read

**SPECIAL SAFETY SECTION  
FREQUENTLY**

## A. GUIDE BAR AND CHAIN

Increase the service life of your Guide Bar and Chain by:

- Using the saw properly and as recommended in this manual.
- Maintaining correct Chain Tension, page 8.
- Proper lubrication, page 10.
- Regular maintenance as described in this section.

### 1. CHAIN MAINTENANCE

#### • Sharpen the chain when:

- Wood chips are small and powdery. Wood chips made by the saw chain should be about the size of the teeth of the chain.
- Saw has to be forced through the cut.
- Saw cuts to one side.

**CAUTION:** Always wear gloves when handling the chain. The chain can be sharp enough to cut you even though it may be too dull to cut wood.

#### a. CLEAN TREE SAP FROM THE CHAIN BEFORE IT IS SHARPENED:

- 1.) Soak chain in a petroleum based solvent or a detergent and water solution
- 2.) Dry chain thoroughly.
- 3.) Immerse the clean chain in light oil until oil seeps into the rivet holes.

**NOTE:** Do not run a chain which has been cleaned without lubricating it first.

#### b. SHARPENING INSTRUCTIONS

Items required:

Gloves	Depth Gauge Tool
7/32" dia. file	Flat file
6" file holder	Vise

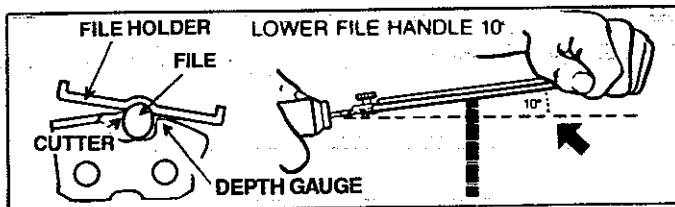

Figure 30

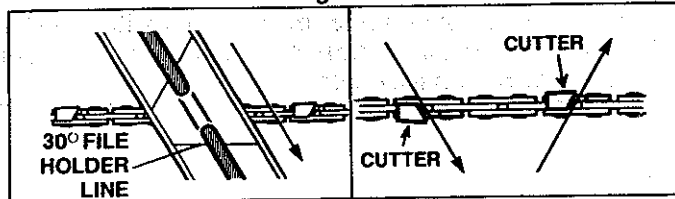

Figure 31

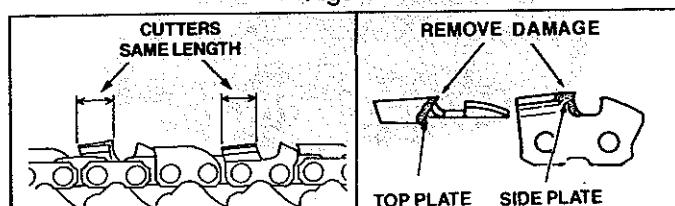

Figure 32

#### 4.) Sharpen cutters.

- a.) Support the square rod on the file holder (with 7/32" round file) on cutter top plate. Figure 30.
- b.) Hold the file holder level with the 30° guide mark parallel to the center of the chain and lower file handle 10°. Figure 30.
- c.) File from inside toward outside of cutter, straight across, on forward stroke only. Use 2 or 3 strokes per cutting edge. Figure 31.
- d.) Keep all cutters the same length. Figure 32.
- e.) File enough to remove any damage to cutting edge (side & top plate) of cutter. Figure 32.
- f.) File P72S chain to meet specifications shown in Figure 33.

#### ⚠ WARNING

Maintain the proper hook angle according to the manufacturer's specification for the chain you are using. Too much hook angle will increase the chance of kickback which can result in serious personal injury. Figure 33 & 35.

#### 5.) Correct Depth Gauges

- a.) Place depth gauge tool over each cutter depth gauge. Figure 34.
- b.) File level with the flat file if depth gauge is higher than the depth gauge tool.
- c.) Maintain rounded front corner of depth gauge with a flat file. Figure 34 & 35.

**NOTE:** The very top of the depth gauge should be flat with the front half rounded off with a flat file.

#### ⚠ WARNING

Depth gauge tool is required to insure proper depth gauge. Filing the depth gauge too deep will increase the chance of kickback which can result in serious personal injury.

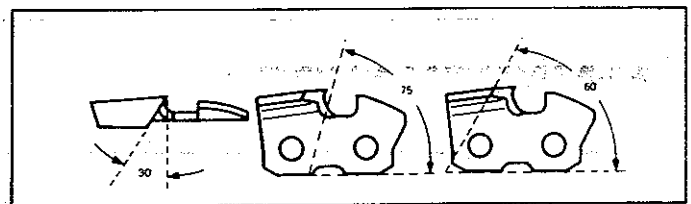

Figure 33

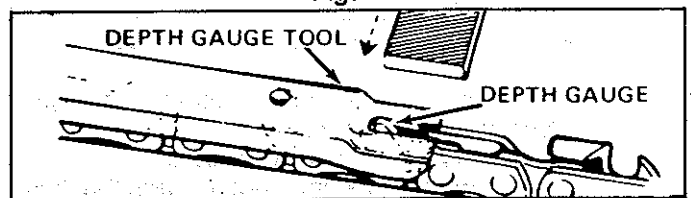

Figure 34

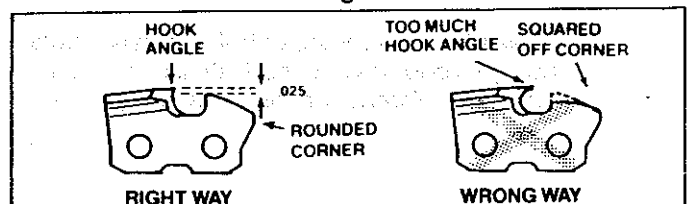

Figure 35



## b. CHAIN REPLACEMENT

- 1.) Replace the chain when cutters or links break.
- 2.) See a qualified service dealer to replace and sharpen individual cutters for matching your chain.
- 3.) Always replace the worn sprocket when installing a new chain to avoid excessive wear to the chain.

## 2. GUIDE BAR MAINTENANCE

- Conditions which can require guide bar maintenance:
  - saw cuts to one side
  - saw has to be forced through a cut
  - inadequate supply of oil to bar and chain.

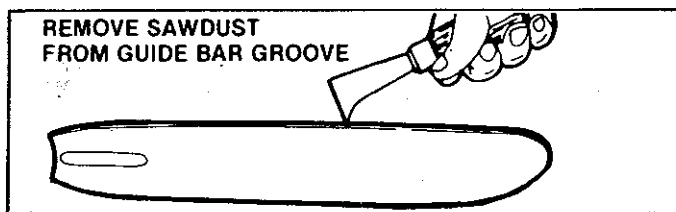

Figure 36

- Check the condition of the guide bar each time the chain is sharpened. A worn guide bar will damage the chain and make cutting more difficult.
- Replace the guide bar when:
  - the inside groove of the guide bar rails is worn.
  - the guide bar is bent or cracked.

  - a. Remove the guide bar to service.
  - b. Clean oil holes at least once for each five hours of operation.
  - c. Remove sawdust from the guide bar groove periodically with a putty knife or a wire. Figure 36.
  - d. Remove burrs by filing the side edges of the guide bar grooves square with a flat file. Figure 37.
  - e. Restore square edges to an uneven rail top by filing with a flat file. Figure 37.

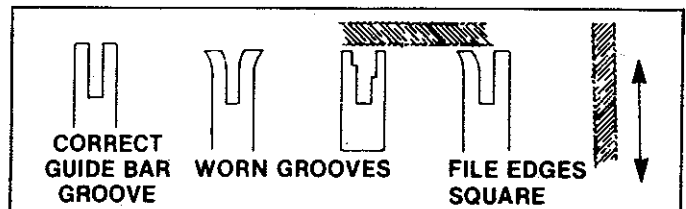

Figure 37

## B. IGNITION AND EXHAUST SYSTEMS

- Carbon deposits will build up on exhaust ports, spark arrestor, muffler, and spark plug as the saw is used. All of these parts should be cleaned at the same time to prevent engine damage, overheating, loss of power, and hard starting.
- Clean parts:
  - as required
  - at least once for each 25-30 hours of operation

### 1. COOLING AND EXHAUST SYSTEM

- Carbon build-up on the cooling and exhaust system can cause the engine to lose power in a cut.
- Keep the spark arrestor clean at all times.
- Replace the spark arrestor when breaks in the screen are found.

Items required:

- wire brush
- 3/8" wrench
- hardwood stick

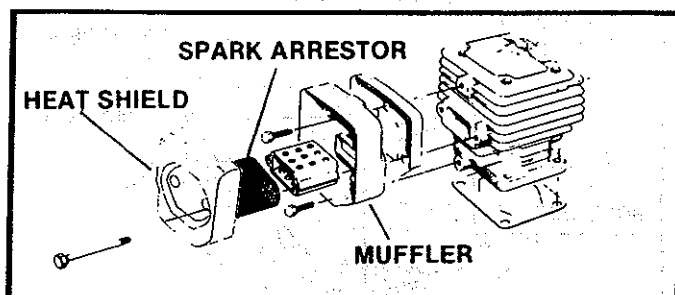

Figure 38

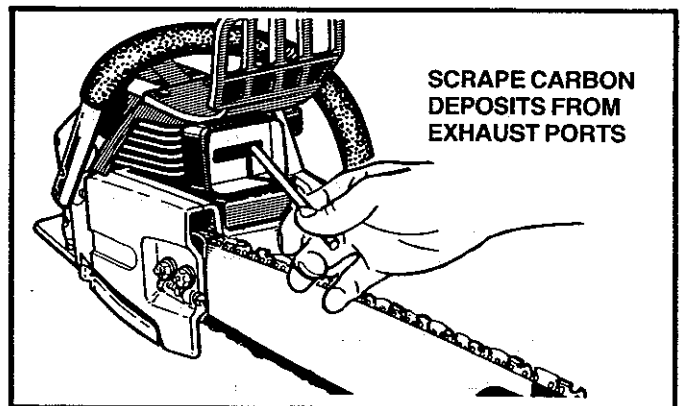

Figure 39

- a. Disconnect the spark plug.
- b. Remove the muffler, baffles, and screen. Figure 38.
- c. Pull the starter rope until the piston moves far enough to close the exhaust ports.
- d. Scrape the carbon deposits from the exhaust ports and surrounding exhaust chamber using a hardwood stick. Figure 39.

**CAUTION:** Do not use a metallic scraping tool to avoid damage to the piston.

- e. Blow out loosened carbon with compressed air.
- f. Clean the spark arrestor screen with a wire brush or replace if breaks in the screen are found.
- g. Reassemble muffler parts.

## 2. SPARK PLUG

- Maintenance is indicated when the engine is hard to start.
- Keep the spark plug:
  - clean
  - properly gapped (.025")

Items Required: Small brush, such as a tooth brush, or a pocket knife.

- Remove the carburetor cover.
- Pull the rubber connector from the spark plug and remove the spark plug from the cylinder.
- Clean deposits from the electrodes of the spark plug with a small brush or a pocket knife.

**NOTE:** Be careful when removing, cleaning, gapping and replacing the spark plug. If it is damaged, it will not work properly and must be replaced.

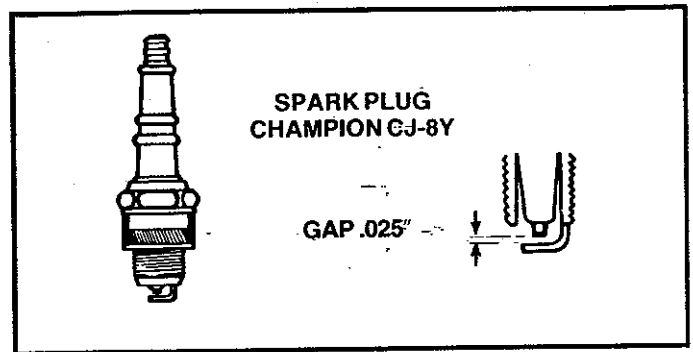

Figure 40

- Set the gap between the electrodes to .025 using a wire or flat gauge. Figure 40.
- Replace the spark plug in the cylinder and attach the rubber connector.
- Replace carburetor cover and knob.

## C. STARTER ROPE REPAIR AND REPLACEMENT

- A starter rope that breaks next to the pulley can be repaired.
- Replace the starter rope if the rope breaks more than 2-3 inches away from the pulley as the rope will be too short to repair properly.

### ⚠ WARNING

Always wear eye protection when servicing the starter rope. The recoil spring beneath the pulley is under tension. If the spring pops out, serious personal injury can result.

**NOTE:** The recoil spring, located beneath the pulley, is under tension. If spring pops out, it will require considerable time and effort to reinstall. For this reason, you may want to let a qualified service dealer handle this repair. If you do try to repair the starter rope and the recoil spring pops out take the unit to your dealer.

- Remove the four screws on the side of the fan housing. Figure 41.

**NOTE:** Notice the different lengths of the screws and their proper locations while removing the screws.

- Remove the fan housing.
- If the starter rope is not broken, release the spring tension by pulling about 12 inches of rope from the pulley and catch the rope in the notch as shown. Figure 42.

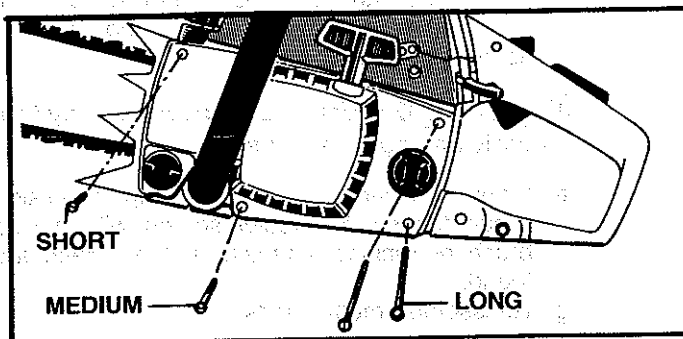



Figure 41

**NOTE:** The tension on the starter spring will be released if the rope has broken.

- Turn the pulley counterclockwise until the spring tension is released.
- Remove the pulley screw in the center of the pulley. Figure 43.
- Lift the pulley *carefully* while gently twisting it counterclockwise , and remove the old rope.
- Move away from the fuel tank and melt the end of the new rope to go into the pulley.
- Allow the melted end to drip once; then while the rope is still hot, pull the melted end through a rag to obtain a smooth, pointed end.
- Feed the rope through the round starter hole in the fan housing. Figure 43.
- Snake rope inside pulley, then through topside pulley hole by pushing the rope from the underside hole with a small round object, such as a Phillips screwdriver. See insert. Figure 43.

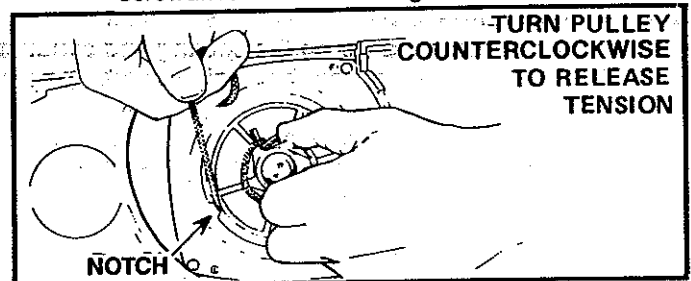

Figure 42

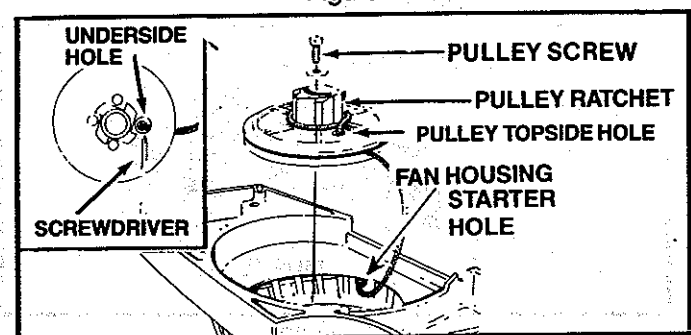





Figure 43

11. Wrap rope counterclockwise  around pulley ratchet and tuck loose end back under rope leaving a 3/8-1/2 inch tail. Pull tightly around ratchet. Figure 43.
12. Pull the rope tightly around ratchet and wrap around the pulley clockwise .
13. Set the pulley into the housing; push it down and engage the spring.
14. Replace and tighten the pulley screw.
15. Pull out 12 inches of rope and catch the rope in the notch in the pulley. Figure 43.
16. Turn the pulley 3 complete turns clockwise  winding up the spring.
17. Hold the pulley, pull the starter rope to the full extent of length then let the rope rewind slowly.
18. Replace fan housing with the four screws in their proper location.

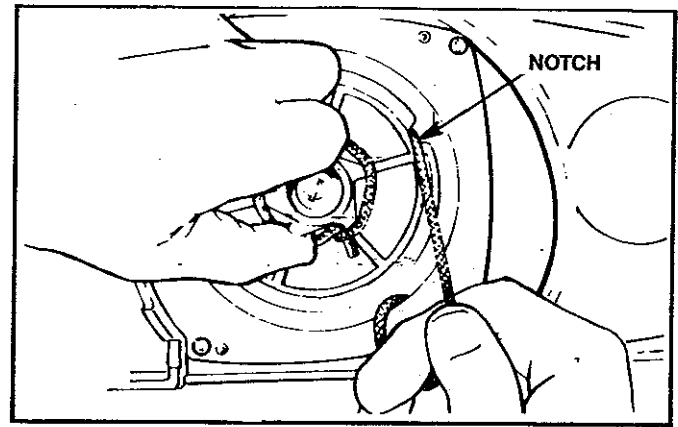

Figure 44

## D. CLUTCH AND DRUM/SPROCKET

### WARNING

Do not start engine without Guide Bar, Chain, and Bar Clamp Housing completely assembled. The clutch can come off without the guide bar and chain completely assembled and serious injury can result. Do not loosen and spin the clutch off the crankshaft with a power tool. The clutch shoes and drum can separate causing the clutch to violently fly apart and serious personal injury can result.

- Take the saw to a qualified service dealer for full clutch inspection and service after each 100 hours of operation. It is recommended that you do not try to service the clutch or drum/sprocket yourself unless you are a competent small engine mechanic and have the proper clutch service tools. Proper disassembly and repair of the clutch is extremely important to the life of the engine and the safety of the operator.
- Clutch maintenance is required when:
  - the chain continues to turn while engine idles after the idle speed screw has been adjusted to its capacity.
  - slippage occurs during a cut.
  - a chattering noise occurs during cutting.
- Clean the clutch, drum/sprocket and surrounding area daily during heavy use of the saw. Check to see that the clutch drum turns freely and smoothly.
- Inspect the drum/sprocket regularly for wear. A worn sprocket will make the chain run erratically and will shorten the life of the bar and chain. Figure 45.
- Replace the drum/sprocket whenever a new chain is installed in order to gain the full life expectancy of the chain. Use the following procedure:
  - 9/16" Socket Wrench
  - 3/4" Socket Wrench

1. Remove the carburetor cover and pull the spark plug away from the rubber connector.

2. Remove the bar clamp, outer guide plate, guide bar, and chain. Figure 46.
  3. Remove the fan housing.
  4. Use a 9/16" socket wrench on the flywheel nut to keep the crankshaft from moving. Figure 47.
- NOTE:** Place the socket handle forward as shown in Figure 47.

### CHAIN WEAR ON DRIVE SPROCKET



Figure 45

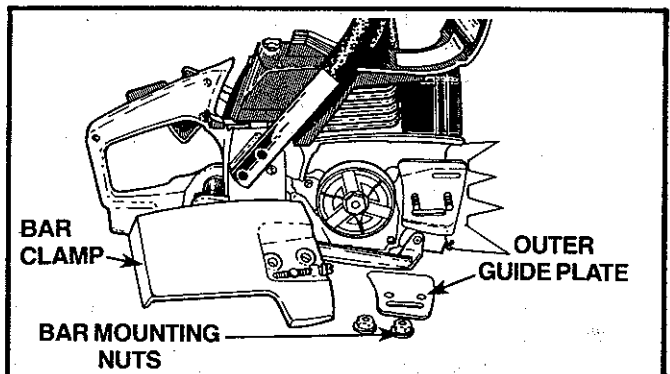

Figure 46

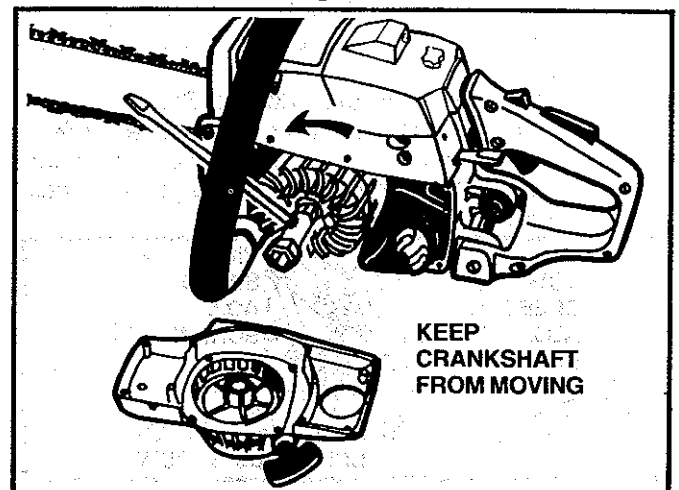

Figure 47

Read  
SPECIAL SAFETY SECTION  
FREQUENTLY

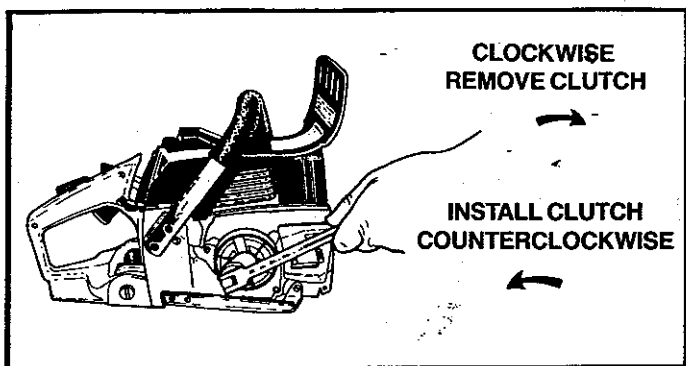

Figure 48

5. Remove the clutch with a 3/4" socket or end wrench in a *clockwise* direction. Figure 48.

**CAUTION:** Do not remove the clutch with a punch or a powerful tool to avoid damage or breakage to the clutch.

6. Remove worn drum/sprocket and replace.
7. Install clutch in a *counterclockwise* direction. Figure 48.
8. Hold flywheel by hand and tighten clutch with 3/4 socket wrench.  
**NOTE:** Do not hold a wrench on the flywheel nut when replacing the clutch. This could loosen the flywheel nut.
9. Reinstall fan housing, bar chain and bar clamp.

## E. CARBURETOR ADJUSTMENTS

- The carburetor has been adjusted at the factory for sea level conditions. Adjustment may become necessary if the unit is used at significantly higher altitudes or if you notice any of the following conditions:
  - Chain moves with the engine at idle speed.
  - Loss of cutting power which is not corrected by air filter or muffler screen cleaning.
  - Engine dies or hesitates when it should accelerate.
- Permanent damage will occur to the engine if incorrect carburetor adjustments are made. It is best to let a qualified service dealer make carburetor adjustments. If you choose to make the adjustments yourself, follow the procedure below very carefully.

### ! WARNING

The chain may be moving during this procedure. Wear your protective gear and observe all of the safety precautions.

#### 1. PREPARATION

- a. Stop engine.
- b. Use a fresh fuel mixture with proper gasoline/oil ratio.
- c. Place the saw on a solid, flat surface and make sure the chain will not contact any object.
- d. Locate the three (3) Carburetor adjusting screws located on the fan housing side of the saw. Figure 49.
- e. Turn the **Low Speed Mixture Screw** and the **High Speed Mixture Screw** clockwise → just until they stop. Do not turn the screws until they are tight as you may damage the needle seats.

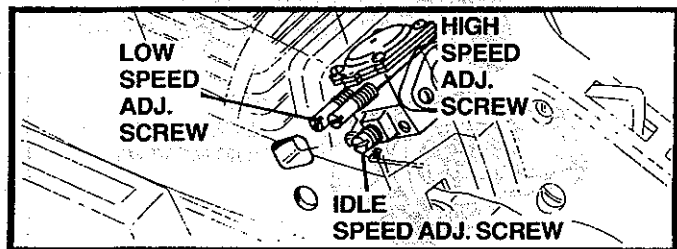

Figure 49

- f. Turn the **Low Speed Mixture Screw** and the **High Speed Mixture Screw** one full turn counterclockwise ←

#### 2. IDLE SPEED ADJUSTMENT — I

- a. Start the engine and allow to idle.
- b. Adjust if the engine dies or stops by turning the **Idle Speed Screw** 1/2 turn clockwise →

**NOTE:** To increase idle speed, turn the idle Speed Screw clockwise →. To decrease idle speed, turn the Idle Speed Screw counterclockwise ←.

- c. Run the engine for a few minutes to bring it up to operating temperature.

**NOTE:** The engine must be at operating temperature for proper adjustments to be made.

#### 3. LOW SPEED MIXTURE ADJUSTMENT

- a. Turn the **Low Speed Mixture Screw** slowly clockwise → until the RPM starts to drop. Note the position.
- b. Turn the **Low Speed Mixture Screw** counterclockwise ← until the RPM speeds up and starts to drop again. Note the position.
- c. Set the **Low Speed Mixture Screw** at the midpoint between the two positions.

#### 4. IDLE SPEED ADJUSTMENT — II

- a. Allow engine to idle.
- b. Adjust if the chain is turning by turning the **Idle Speed Screw** counterclockwise ←.
- c. Squeeze the throttle trigger; the saw should accelerate without hesitating.

**NOTE:** It may be necessary to recheck the low speed mixture setting after the idle speed has been reduced by repeating "Low Speed Mixture Adjustment" as in step 3 above.

#### 5. HIGH SPEED MIXTURE ADJUSTMENT

- a. Make a test cut.
- b. Adjust if the saw smokes or seems to have low power in the test cut by turning the **High Speed Mixture Screw** 1/16th of a turn clockwise →.
- c. Repeat test cut.
- d. Repeat adjustment until the saw runs smoothly.

**CAUTION:** Never set the High Speed Mixture Screw less than 7/8 turn open. This is too lean a setting and will damage your engine.

## 6. IDLE SPEED ADJUSTMENT — III

Recheck for proper idle mixture setting.

**NOTE:** It may be necessary to repeat Idle Speed Adjustment — I and Low Speed Mixture Adjustment.

## F. AIR FILTER

- **A dirty air filter:**
  - reduces cutting power
  - increases fuel consumption
- **Clean the Air Filter:**
  - frequently, especially under very dusty conditions.
  - always after 10 tanks of fuel mixture or 5 hours of operation, whichever is less.

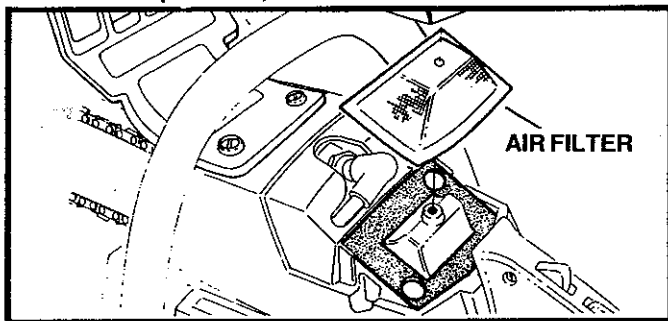



Figure 50

## 7. CHECK ACCELERATION

Adjust if there is a slight hesitation, by turning the Low Speed Mixture Screw 1/16 of a turn at a time counterclockwise  until you have smooth acceleration.

**NOTE:** Check to be sure the chain is not turning when engine is idling. If chain moves at idle speed, repeat Idle Speed Adjustment — II.

**CAUTION:** Never operate the unit without the air filter in place to avoid damage to the engine.

Items Required: soft bristled brush, such as a paint brush.

1. Clean off the carburetor cover and the area around it.
2. Close choke to prevent dirt from entering the carburetor.
3. Remove the carburetor cover. Figure 50.
4. Remove the air filter carefully.
5. Soak the filter in soap and water.

**CAUTION:** Do not use gasoline or other flammable liquid to clean the filter to avoid creating a fire hazard.

6. Brush away all dust and debris from the filter.
7. Allow filter to dry.
8. Brush away all debris from surfaces which were covered by the carburetor cover.
9. Replace filter and carburetor cover.

## G. COUNTER-VIBE® ANTI-VIBRATION SYSTEM

This saw is equipped with a counter vibration system consisting of 5 isolator mounts. Figure 51. The Isolator Mounts reduce engine and chain vibration similar to the way shock absorbers on a car reduce jolts and bumps in the road.

1. Check isolators each time the saw is used.
2. Replace isolators when:
  - vibration increases
  - mounts develop an out of round or swollen shape usually caused from exposure to gasoline and oil for long periods of time.
3. Replace all five isolators when a failure to one occurs.

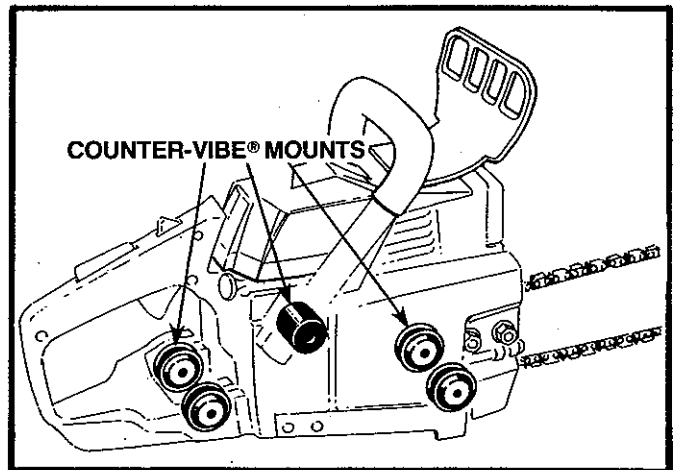

Figure 51

## H. STORAGE

When your saw is to be stored for over 30 days always:

1. Drain fuel tank in a safe manner (see "Important Points," page 9).
  2. Start engine and allow to run at idle speed until the engine stops.
- NOTE:** This will remove most of the fuel from the fuel system.

**CAUTION:** Wear protective gloves when handling the chain. The chain is sharp and can cut you even when it is not moving.

3. Drain oil tank.
4. Remove, clean, and dry the bar and chain.
5. Store the chain in a container filled with oil to prevent rust.
6. Apply a coating of oil to the entire surface of the bar and wrap it in heavy paper, cloth or plastic.
7. Clean the outside surfaces of the engine.
8. Store the saw in a dry place out of the reach of children and away from where fuel vapors can reach open flames from hot water heaters, furnaces, etc.

# I. TROUBLE SHOOTING CHART

TROUBLE	CAUSE	REMEDY
ENGINE WILL NOT START	<ol style="list-style-type: none"> <li>1. Ignition Switch off.</li> <li>2. Fuel tank empty.</li> <li>3. Spark Plug not firing.</li> <li>4. Fuel not reaching carburetor.</li> <li>5. Engine flooded.</li> <li>6. Compression low.</li> </ol>	<ol style="list-style-type: none"> <li>1. Move switch to "Start."</li> <li>2. Fill tank with correct fuel mixture, page 9.</li> <li>3. Install new plug, page 18.</li> <li>4. Check for dirty fuel filter; clean. Check for kinked or split fuel line; repair or replace.</li> <li>5. See Starting Instructions, page 11.</li> <li>6. Contact a qualified service dealer.</li> </ol>
ENGINE WILL NOT IDLE PROPERLY	<ol style="list-style-type: none"> <li>1. Idling speed set too low.</li> <li>2. Idle speed set too high.</li> <li>3. Low speed screw requires adjustment.</li> <li>4. Crankshaft seals worn.</li> <li>5. Compression low.</li> </ol>	<ol style="list-style-type: none"> <li>1. Adjust idle speed screw clockwise to increase speed, page 20.</li> <li>2. Adjust idle speed screw counterclockwise to reduce speed, page 20.</li> <li>3. See Carburetor Adjustments, page 20.</li> <li>4. Replace seals or contact a qualified service dealer.</li> <li>5. Contact a qualified service dealer.</li> </ol>
ENGINE WILL NOT ACCELERATE, LACKS POWER OR DIES IN THE CUT	<ol style="list-style-type: none"> <li>1. Carburetor requires adjustment.</li> <li>2. Air filter dirty.</li> <li>3. Spark Plug fouled.</li> <li>4. Carbon build-up.</li> <li>5. Low Compression.</li> </ol>	<ol style="list-style-type: none"> <li>1. See Carburetor Adjustments, page 20.</li> <li>2. Clean or replace air filter, page 21.</li> <li>3. Clean or replace Spark Plug and regap, page 18.</li> <li>4. Clean exhaust system including spark arrestor, page 17.</li> <li>5. Contact a qualified service dealer.</li> </ol>
ENGINE SMOKES EXCESSIVELY	<ol style="list-style-type: none"> <li>1. Choke partially on.</li> <li>2. High speed needle requires adjustment.</li> <li>3. Air filter dirty.</li> <li>4. Oil rich fuel mixture.</li> <li>5. Crankcase leak.</li> </ol>	<ol style="list-style-type: none"> <li>1. Push Choke in.</li> <li>2. See Carburetor Adjustments, page 20.</li> <li>3. Clean or replace air filter, page 21.</li> <li>4. Empty fuel tank and refill with correct fuel mixture, page 9.</li> <li>5. Contact a qualified service dealer.</li> </ol>
ENGINE RUNS HOT	<ol style="list-style-type: none"> <li>1. Fuel Mixture Incorrect.</li> <li>2. Spark Plug Incorrect.</li> <li>3. Carbon build-up.</li> <li>4. High Speed Mixture set too low.</li> </ol>	<ol style="list-style-type: none"> <li>1. See Engine Fuel Mixture, page 9.</li> <li>2. Replace with correct plug, page 18.</li> <li>3. Clean exhaust systems including spark arrestor, page 17.</li> <li>4. See Carburetor Adjustments, page 20.</li> </ol>
OIL INADEQUATE FOR BAR AND CHAIN LUBRICATION	<ol style="list-style-type: none"> <li>1. Oil tank empty.</li> <li>2. Oil pump or oil filter clogged.</li> <li>3. Guide bar oil hole blocked.</li> </ol>	<ol style="list-style-type: none"> <li>1. Fill oil tank, page 10.</li> <li>2. Contact a qualified service dealer.</li> <li>3. Remove bar and clean, page 7 &amp; 17.</li> </ol>
CHAIN MOVES AT IDLE SPEED	<ol style="list-style-type: none"> <li>1. Carburetor requires adjustment.</li> <li>2. Clutch requires repair.</li> </ol>	<ol style="list-style-type: none"> <li>1. See Carburetor Adjustments, page 20.</li> <li>2. Contact a qualified service dealer.</li> </ol>
CHAIN DOES NOT MOVE WHEN ENGINE IS ACCELERATED	<ol style="list-style-type: none"> <li>1. Chain tension too tight.</li> <li>2. Carburetor requires adjustment.</li> <li>3. Guide bar rails pinched.</li> <li>4. Clutch slipping.</li> </ol>	<ol style="list-style-type: none"> <li>1. See Chain Tension, page 8.</li> <li>2. See Carburetor Adjustments, page 20.</li> <li>3. Repair or replace, page 7 &amp; 17.</li> <li>4. Contact a service dealer.</li> </ol>
CHAIN CLATTERS OR CUTS ROUGHLY	<ol style="list-style-type: none"> <li>1. Chain tension incorrect.</li> <li>2. Cutters dull, improperly sharpened; depth gauges too high.</li> <li>3. Sprocket worn.</li> <li>4. Chain wear due to contact with dirt, sand or frozen wood.</li> <li>5. Cutters damaged after striking foreign material.</li> </ol>	<ol style="list-style-type: none"> <li>1. See Chain Tension, page 8.</li> <li>2. See Chain Sharpening Instructions, page 16.</li> <li>3. Replace, page 17.</li> <li>4. Resharpener or replace Chain, page 7 &amp; 16.</li> <li>5. Contact a qualified service dealer. Sharpen all cutters evenly and uniformly or replace Chain. See Chain Sharpening Instructions, page 16.</li> </ol>
CHAIN STOPS WITHIN THE CUT	<ol style="list-style-type: none"> <li>1. Chain cutter tops not filed flat.</li> <li>2. Guide bar burred or bent; rails uneven.</li> <li>3. Clutch slipping.</li> </ol>	<ol style="list-style-type: none"> <li>1. See Chain Sharpening Instructions, page 16.</li> <li>2. Repair or replace Guide Bar, page 7 &amp; 17.</li> <li>3. Contact a qualified service dealer.</li> </ol>
CHAIN CUTS AT AN ANGLE	<ol style="list-style-type: none"> <li>1. Cutters damaged on one side.</li> <li>2. Chain dull on one side.</li> <li>3. Guide bar bent, or worn.</li> </ol>	<ol style="list-style-type: none"> <li>1. Resharpener until all cutters have equal angles and lengths, page 16.</li> <li>2. Resharpener until all cutters have equal angles and lengths, page 16.</li> <li>3. Replace guide bar, page 7.</li> </ol>

## J. MAINTENANCE CHART

		before starting work	after finishing work or daily	after each refueling stop	weekly	monthly	if faulty	if damaged	as required	see page:
Complete machine	Visual inspection (condition, leaks)	x		x						
	Clean		x							
Throttle trigger, safety throttle lock, stop switch	Check operation	x		x						10
Filter in fuel tank	Clean Felt					x				
	Replace felt							x		
Fuel tank	Clean					x				
Chain oil tank	Clean					x				
Chain lubrication	Check	x								10
Saw chain	Inspect, also check sharpness	x		x						
	Check chain tension	x		x						8
	Sharpen								x	16
Guide bar	Inspect (wear, damage)	x								17
	Clean				x		x			17
	Lubricate sprocket nose		x							
	Deburr				x					17
	Replace							x	x	7
Chain sprocket	Check				x					19
Air filter	Clean	x					x			21
	Replace							x		21
Exhaust ports	Clean		x							17
Cylinder fins	Clean					x				17
Carburetor	Check idle adjustment – chain must not turn	x		x						20
	Readjust idle								x	20
Spark plug	Readjust electrode gap						x			18
All accessible screws and nuts (not adjusting screws)	Tighten	x								
Vibration mounts	Inspect				x					21
	To be replaced by a qualified Service Dealer							x		
Spark arrestor screen	Inspect	x								17
	Clean or replace							x		17

# PARTS LIST

## A. ILLUSTRATION and DESCRIPTION 1

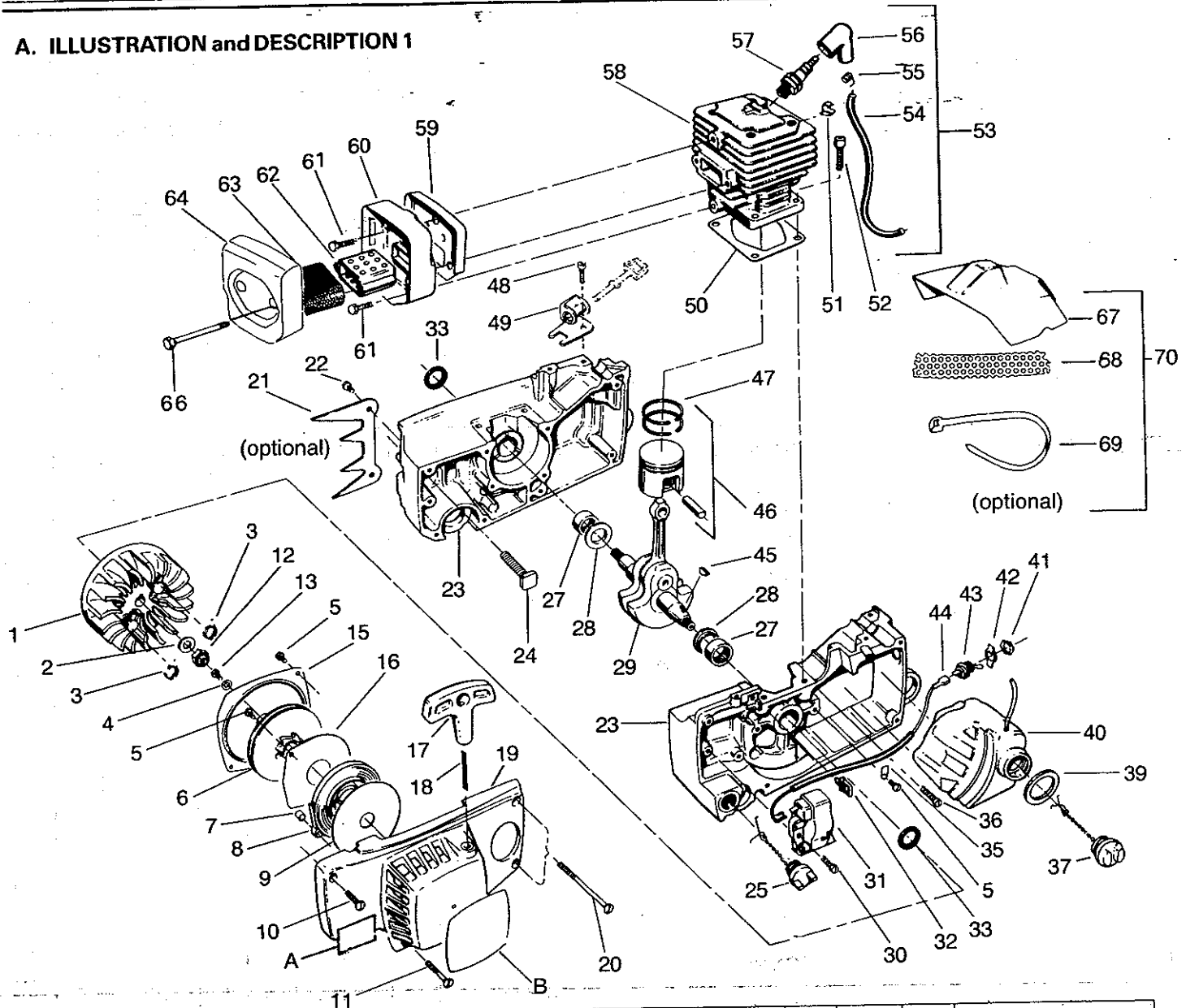

KEY NO.	PART NO.	QTY.	DESCRIPTION	KEY NO.	PART NO.	QTY.	DESCRIPTION	KEY NO.	PART NO.	QTY.	DESCRIPTION
				24	30039	2	Kit- Stud Bar Replacement	49	10347	1	Bracket & Bushing Assembly
1	39095	1	Flywheel Ass'y. (incl. #3)	25	10444	1	Oil Cap Assembly	50	19129*	1	Cylinder Gasket
2	1626	1	Washer- Flywheel	27	32051	2	Bearing- Crankshaft	51	15195	1	Clip- High Tension Lead Cylinder
3	23817	2	Spring- Starter Dog	28	15354	2	Thrust Washer- Crankshaft	52	1624	4	Cylinder Screw- 1/4" x 20"
4	15123	1	Washer- Starter Pulley	29	24492	1	Crankshaft Ass'y. (incl. Connecting Rod and Bearing)	53	39102	1	High Tension Lead Assembly (incl. 53, 54, 55)
5	1726	6	Screw- 8-32 - 3/4" Hex Hd.-Disc. Mounting also Air Baffle and Clamp Lead	30	15425	2	Screw- 10-24 - 3/4" Module Mnt.	54	39096	1	High Tension Lead
6	28487	1	Pulley Starter	31	38093	1	Ignition Module (incl. #44&53)	55	39071	1	Connector Spark Plug
7	24329	1	Bushing Recoil Spring	32	24334	1	Clamp- High Tension Lead- Crankcase	56	39097	1	Boot- Spark Plug
8	42051	1	Spring- Starter Recoil	33	19097*	2	Seal- Crankshaft	57	30073	1	Spark Plug
9	42053	1	Disc. Recoil Spring- Outer	35	23661	2	Clamp- Module Lead	58	12066	1	Cylinder
10	15364	1	Screw- 10-24 - 1- Oval Hd. Fan Housing (Top Front)	36	15238	9	Screw 10-24 - 3/4" Fil Hd. Crankcase	59	24388	1	Back Plate- Muffler
11	15365	1	Screw- 10-24 x 1- 3/8- Fan Housing (Lower Front)	37	10331	1	Fuel Cap Assembly	60	24387	1	Muffler Body
12	1722	1	Flywheel Nut 3/4-24	38	19122*	1	Seal- Fuel Tank Neck	61	15374	2	Screw- 1/4" x 20 - 3/4" Hex Hd. Muffler Body to Cylinder
13	15036	1	Screw - 10 - 24 x 1/2 - Starter Pulley	39	19122*	1	Fuel Tank Assembly (incl. #37; and from page 25, # 35 & 36)	62	24384	2	Diffuser- Muffler
15	24232	1	Air Baffle	40	10286	1	Nut- Switch Mounting	63	24385	1	Screen- Spark Arrestor
16	42054	1	Disc. Recoil Spring Inner	41	23575	1	Plate- Ignition Switch	64	26800	1	Muffler Cover
17	42056	1	Handle Starter Rope	42	24658	1	Switch- Toggle	66	15375	2	Screw- 1/4" x 20 - 2 1/2" Hex Cap Muffler Cover
18	42052	1	Rope Starter (Bulk 8128)	43	23732	1	Leadwire- Switch	67	24845	1	Cover Carburetor-with Rear Vent-Optional
19	12034	1	Fan Housing Assembly	44	39115	1	Key- Flywheel	68	11746	1	Screen- Winter (Optional)
20	15366	2	Screw- 10-24 - 3/4" Fan Housing (Rear)	45	2595	1	Piston Assembly (incl. Piston Pin and Rings)	69	24675	6	Tie Strap (Optional)
21	24476	1	Spur-Optional	46	10314	1	Rings- Piston	70	68063	1	Winter Kit (incl. 67, 68 & 69)-optional
22	15434	2	Screw- 10-24 - 3/4" Hex Hd. Spur	47	24332	2	Choke Bracket		66640	1	Operator's Manual (not shown)
23	10696	1	Crankcase Ass'y (incl. #24, 25 & 33 this page; from page 25 includes #17, 30, 47 and one of 34.)	48	15368	1			66051	1	Bow Guide Manual (not shown)
								Decals			
								A	24885	1	Decal- Professional User
								B	26846	1	Decal Fan Housing

\*Indicates contents of Gasket Kit #69190 from page 25.  
Key Numbers Excluded: #26, 38 & 65



## B. ILLUSTRATION and DESCRIPTION 2

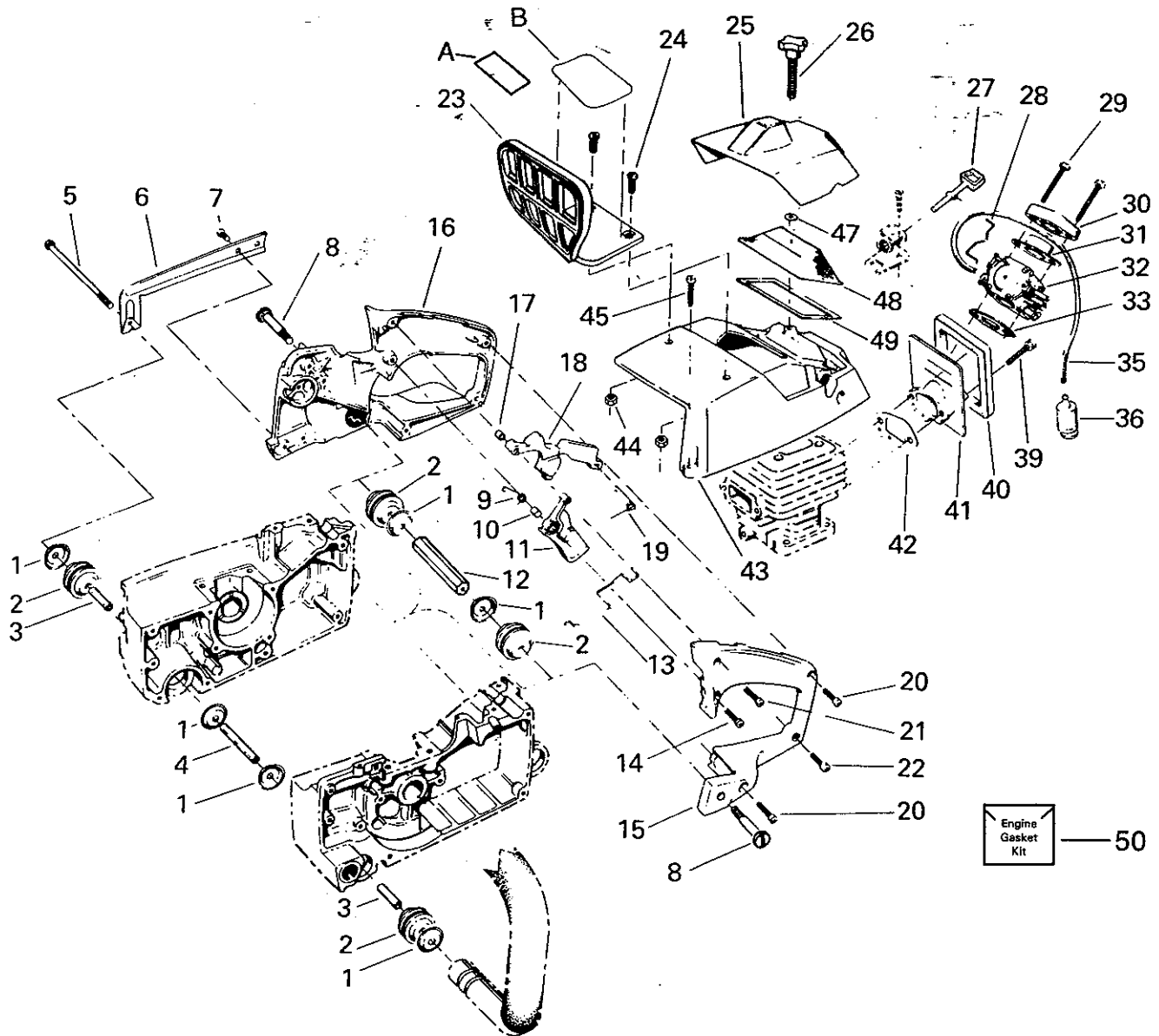

KEY NO.	PART NO.	QTY.	DESCRIPTION	KEY NO.	PART NO.	QTY.	DESCRIPTION	KEY NO.	PART NO.	QTY.	DESCRIPTION
1	24376	6	Cup-Isolator	17	32053	1	Bushing- Throttle Lock	35	21028	1	Fuel Line
2	—	4	Isolator-Powerhead Rear Handle	18	24357	1	Throttle Lock	36	91878	1	Fuel Pick-up Ass'y
	24373	—	Use on Guide Bar Powerhead	19	24378	1	Spring-Throttle Lock	39	15414	2	Screw-10-24 - 1 1/4-Hex Hd. Adaptor to Cylinder
	24528	—	Use on Bow Guide Powerhead	20	15403	2	Screw-10-24x13/16 Fil. Hd. Rear Handle	40	19107 *	1	Seal-Carburetor Adaptor
3	15362	2	Spacer-Front Handlebar Isolator Mount	21	15393	1	Screw-8-32 - 1 1/8 Fil. Hd. Rear Handle Throttle Lock	41	24229	1	Carburetor Adaptor
4	15361	1	Spacer-Front Handlebar-Center-Isolator Mount	22	15608	1	Screw-8-32x19/32 Fil.Hd. Rear Handle Lower Handguard	42	19101 *	1	Gasket-Adaptor to Cylinder
5	15391	1	Screw-1/4-20 - 5/16	23	25948	2	Screw-10-24 - 1/2	43	25895	2	Cylinder Shield
6	—	1	Handle Brace	24	15406	2	Cover-Carburetor	44	15217	2	Nut-# 10-24
	11963	—	Use on Guide Bar Powerhead	25	24976	1	Knob-Carburetor Cover	45	15168	3	Screw-10-24 - 1/4 Fil. Hd. Cylinder Shield to Crankcase
	11964	—	Use on Bow Guide Powerhead	26	24482	1	Choke Rod	47	24877	1	Retainer-Carb. Cover Knob
7	15194	2	Screw-1/4-20 - 3/4 Button Hd.	27	25919	1	Wire-Choke	48	24548	1	Air Filter
8	15462	2	Shoulder Screw 1/4-20-Isolator	28	24383	1	Screw-10-24 - 1 1/4 Fil. Hd. Carburetor to Adaptor	49	19123 *	1	Gasket-Air Filter
9	25469	1	Spring-Trigger	29	15245	2	Bracket-Carburetor Seal	50	69190	1	Engine Gasket Kit (Optional)
10	32059	1	Bushing-Trigger				Carburetor (See Page 27)				*Indicates contents
11	26013	1	Throttle-Trigger				Gasket-Carburetor to Adaptor				Decal-Kickback
12	25258	1	Spacer-Isolator (Center)	30	19104 *	1	Seal-Adaptor Shield	A'	—	1	Guide Bar Powerhead
13	24699	1	Wire Throttle	31	24349	1	Bracket-Carburetor Seal	B	26850	—	Bow Guide Powerhead
14	15369	1	Shoulder Screw-10-24x5/8 Fil. Hd.	32	35094	1	Carburetor (See Page 27)		26156	—	Decal-Starting Instructions
15	11826	1	Flt. Hd.-Throttle Trigger	33	19099 *	1	Gasket-Carburetor to Adaptor		26921	1	
16	12023	1	Rear Handle Left								
			Rear Handle Right								

Key No's. Excluded: # 34, 37, 38 & 46.

\*Indicates contents of Engine Gasket Kit, Key Number 50

C. ILLUSTRATION and DESCRIPTION 3

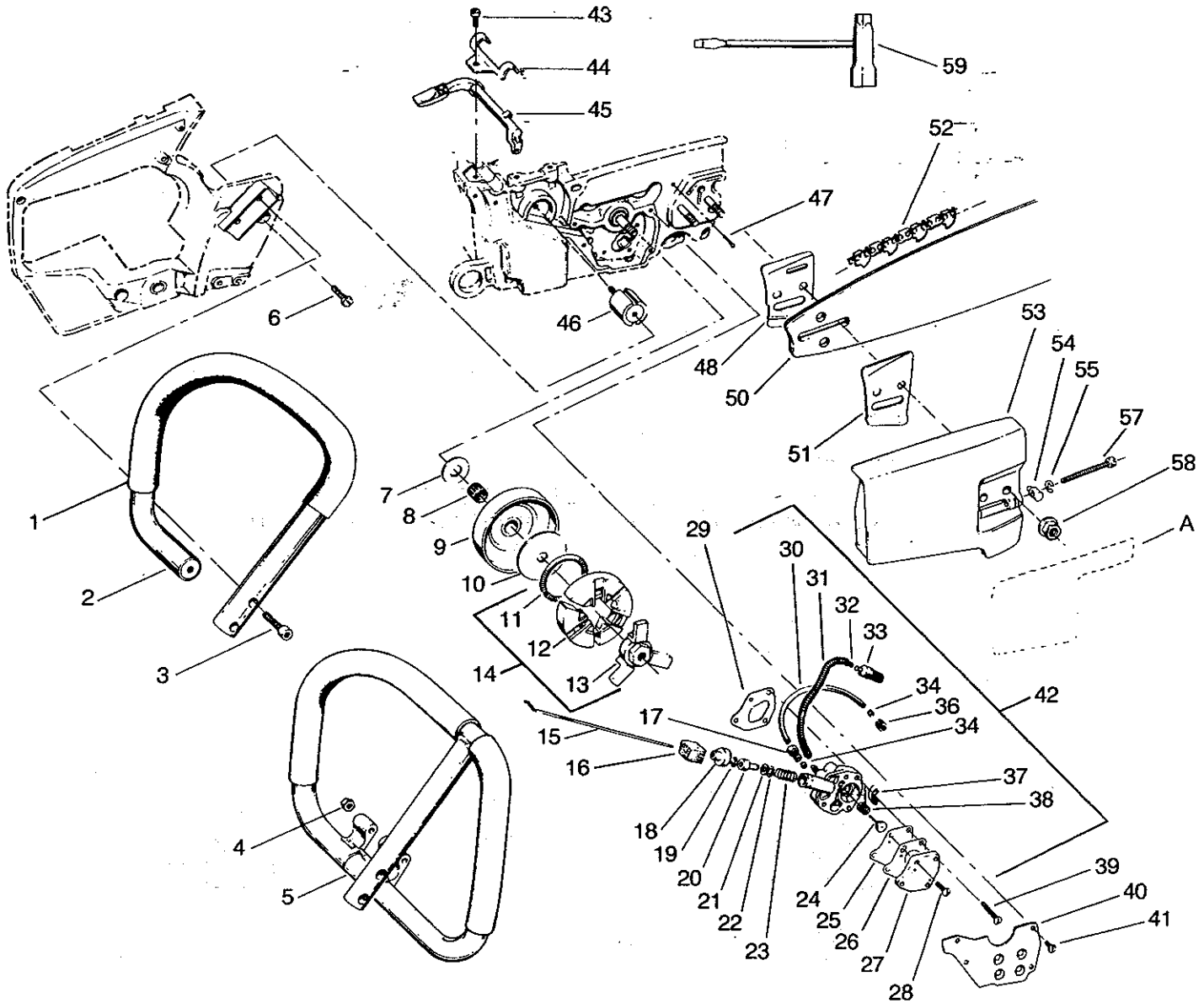

KEY NO.	PART NO.	QTY.	DESCRIPTION	KEY NO.	PART NO.	QTY.	DESCRIPTION	KEY NO.	PART NO.	QTY.	DESCRIPTION
1	69171	1	Kit-Grip-Handlebar (Velvet)	23	23358	1	Spring	44	24351	1	Bracket Lever to Crankcase
2	22276	1	Handlebar Assembly	24	22197	1	Ass'y-Button & Pintle	45	24348	1	Lever-Manual Oiler
3	1711	2	Screw-1/2-20 x 1-Socket Hd.- Handlebar to Crankcase	25	24345	1	Diaphragm	46	-	1	Isolator Side
4	1615	1	Locknut-1/2-20-Wraparound Handle	26	19102	1	Gasket-Cover to Body	47	24225	1	Use on Guide Bar Powerhead
5	69163	1	Handlebar-Wraparound Handle- Optional for Guide Bar Powerhead only	27	25967	1	Cover-Pump	48	24637	1	Use on Bow Guide Powerhead
6	15406	1	Screw-10-24 x 1/2-Pan. Hd.- Side Isolator	28	15297	1	Screw-8-16 x 1/2-Pan. Hd.- Oil Pump Cover	50	See p. 27	1	Kit-Oil Tank Vent Replacement
7	15357	1	Thruster Washer	29	19103	1	Gasket-Oiler Ass'y. to Crankcase	51	25924	1	Guide Bar Plate-Inner
8	32049	1	Bearing-Clutch	30	21038	1	Discharge Line Oil (Bulk 8115)	52	See p. 27	1	Guide Bar Plate-Outer
9	48069	1	Drum & Sprocket Assembly	31	24677	1	Spring-Oil Line Protector	53	-	1	Chain
10	24465	1	Plate Clutch	32	21031	1	Oil Line (Bulk 8132)	53	-	1	Bar Clamp Ass'y. (incl. 54-57)
11	24353	1	Spring-Clutch	33	24676	1	Weight-Oil Pick-up Line	54	11637	1	Use on Guide Bar Powerhead
12	24352	3	Shoe-Clutch	34	2464	2	Sleeve-1/4 Tubing	55	11692	1	Use on Bow Guide Powerhead
13	11625	1	Spider-Clutch	36	15422	1	Tubing Nut-Slotted	56	25044	1	Pin-Bar Adj.
14	10291	1	Clutch Ass'y. (incl. 11, 12, & 13)	37	24691	1	Foam-Oil Pump Vent	57	24419	1	"E" Ring Adj. Screw
15	24347	1	Rod-Manual Oiler	38	23699	1	Spring-Diaphragm	57	15385	1	Screw-10-24 x 2 1/2"
16	23373	1	Boot-Oiler Rod	39	15401	3	Screw-8-32 x 1-Pan. Hd.- Pump to Crankcase	58	15445	2	Bar Adj.
17	2615	1	Tubing Nut	40	24399	1	Cover Plate-Oiler	59	31107	1	Flange Nut Mounting- 1/4-18
18	23356	1	Cap-Oil Pump	41	15004	4	Screw-8-32 x 1/2-Pan. Hd.- Cover Plate	Decal A	26845	1	Scrench
19	1611	1	Retainer Ring	42	69062	1	Oil Pump Service Kit- (inci. 16-28, 30-33, 37-38 one of 34)				Decal- Bar Clamp
20	23357	1	Plunger	43	15319	1	Screw-10-24 x 3/4-Fil. Hd.- Bracket to Crankcase				
21	19029	1	"O" Ring-Quad Ring								
22	15418	1	Washer-Oiler								

Key Numbers Excluded: #'s 35, 49 & 56  
 \*Indicates contents of Gasket Kit #69190, page 25.

## D. CARBURETOR ASSEMBLY #35094

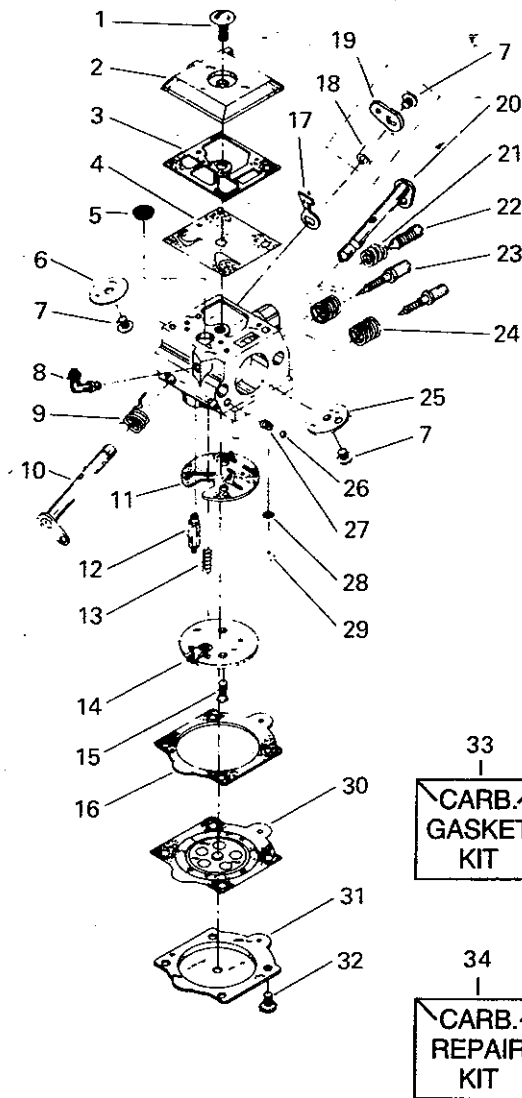

KEY NO.	PART NO.	QTY.	DESCRIPTION
1	35115	1	Screw - Pump Cover
2	35099	1	Cover - Fuel Pump
3	35109	1	Gasket - Fuel Pump
4	35069	1	*Screen - Inlet
5	35113	1	*Diaphragm - Fuel
6	35102	1	Valve - Throttle
7	35015	3	*Screw - Valve
8	35123	1	Fitting - Inlet (Elbow)
9	35119	1	Spring - Throttle Ret.
10	35101	1	Shaft Ass'y. - Throttle
11	35111	1	*Gasket - Circuit
12	35008	1	*Valve - Inlet Needle
13	35118	1	*Spring - Mtrg. Lever
14	35126	1	Plate Ass'y. - Circuit
15	35116	2	*Screw - Circuit Plate
16	35108	1	*Gasket - Mtrg. Diaphragm
17	35105	1	Stop - Throttle
18	35125	1	Bushing - Throttle Lv.
19	35097	1	Lever - Throttle (Outer)
20	35103	1	Shaft Ass'y. - Choke
21	35121	1	Spring - Idle Screw
22	35117	1	Screw - Idle Adj.
23	35122	2	Needle - Hi & Lo
24	35023	2	*Spring - Needle
25	35104	1	Valve - Choke
26	35107	1	*Ball - Choke Friction
27	35022	1	*Spring - Choke Friction
28	35124	1	*Screen - Check Valve
29	35096	1	*Ring - Screen Retaining
30	35114	1	*Diaph. Ass'y. - Mtrg.
31	35098	1	Cover - Mtrg. Diaphragm
32	35021	4	*Screw Ass'y. - Mtrg. Cover
33	35112	1	Gasket Kit (Incl. #3 & 16) - Optional
34	35127	1	*Kit - Kwik Repair - Optional (*Indicates contents)

## E. GUIDE BAR AND CHAIN INFORMATION

GUIDE BAR	GUIDE BAR NO.	CHAIN NO.	DESCRIPTION & DRIVE LINKS
16" Control Tip*-S.N.R.**	44208	51264	P72S-60
18" Control Tip*-S.N.R.**	44209	51265	P72S-66
20" Control Tip*-S.N.R.**	44246	51266	P72S-70

\*\* Replaceable Sprocket Nose

### REPAIR PARTS FOR P72S CHAIN: 3/8 PITCH, .050 GAUGE

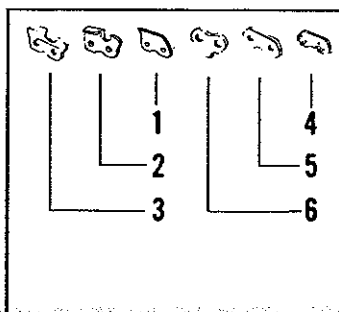

KEY NO.	PART NO.	DESCRIPTION
1	52083	Guard Drive Link
2	52082	L. H. Cutter
3	52081	R. H. Cutter
4	52014	Pre-Set Tie Strap
5	5295	Tie Strap
6	5297	Drive Link
-	52078	Chain Repair Kit

## **PARTS AND SERVICE**

Your Beaird-Poulan/Weed Eater product has been expertly engineered and carefully manufactured to rigid quality standards. As with all mechanical products, some adjustment or part replacement may be necessary during the life of your unit.

### **FOR SERVICE OR REPLACEMENT PARTS:**

1. Consult the yellow pages of your phone directory for the name of the nearest Beaird-Poulan/Weed Eater Master Service Dealer (under saws or lawnmowers) or Skil Service Center (under tools-electric).
2. For replacement parts, have available the following information:
  - a. Name of the unit
  - b. Model number
  - c. Part Number or Description of Part

**NOTE:** Beaird-Poulan/Weed Eater provides parts and service through its authorized distributors and dealers; therefore, all requests for parts and service should be directed to your local dealer(s). The philosophy of Poulan® is to continually improve all of its products. Written notices of changes and improvements are sent to Poulan® Dealers. If the operating characteristics or the appearance of your saw differs from those described in this Operator's Manual, please contact your local Poulan® Dealer for updated information and assistance. Always update your product when improvements are made available, especially those related to safety. Parts and repair service are not available directly from Beaird-Poulan/Weed Eater, Division Emerson Electric Co.

**BEAIRD-POULAN / WEED EATER**

Division Emerson Electric Co.  
Shreveport, Louisiana 71139-9329