

ROTARY LAWN MOWER -- MODEL NUMBER HD3X (MFG. ID. NUMBER 96116000202)

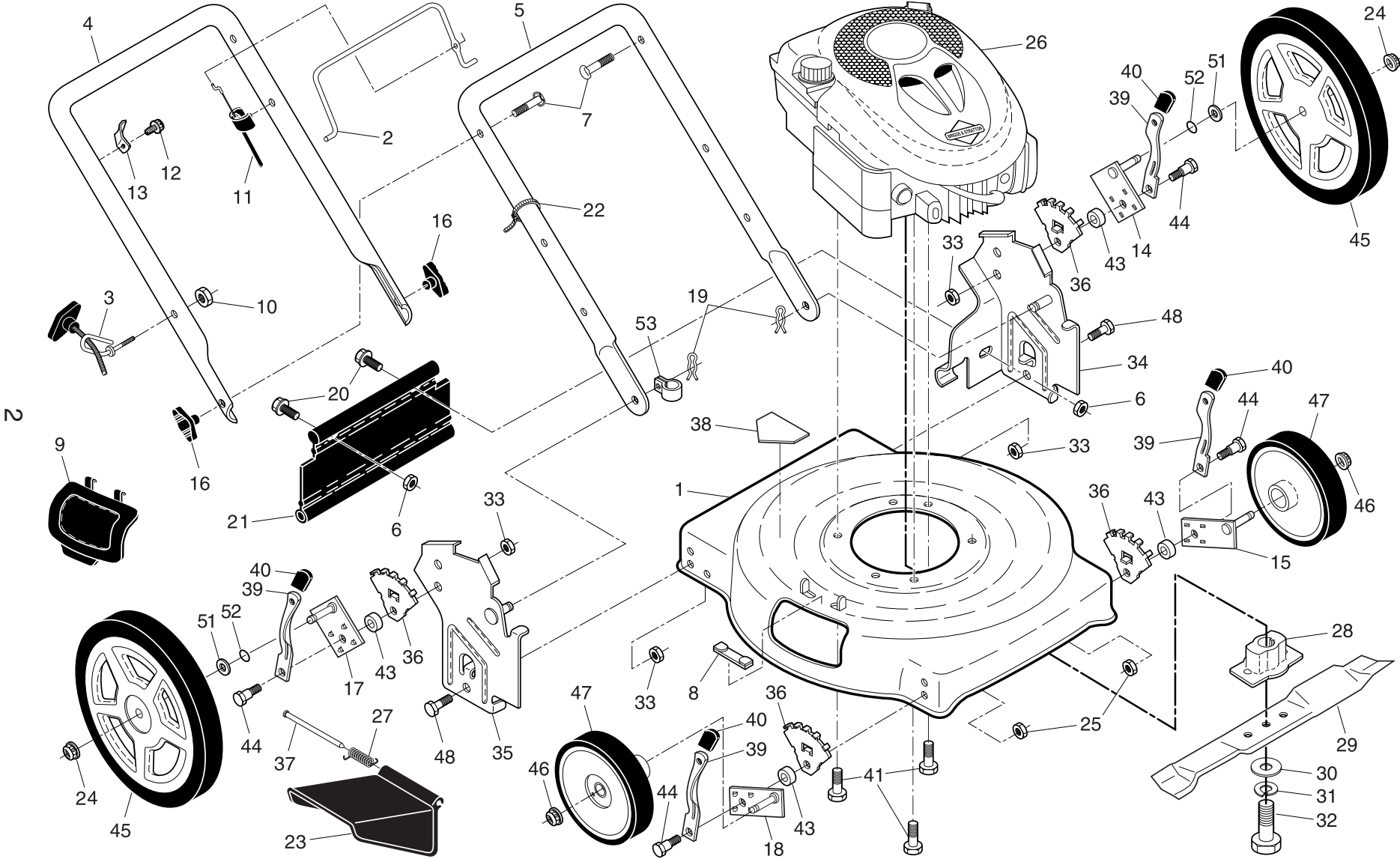

ROTARY LAWN MOWER - - MODEL NUMBER **HD3X** (MFG. ID. NUMBER 96116000202)

KEY NO.	PART NO.	DESCRIPTION	KEY NO.	PART NO.	DESCRIPTION
1	191645	Lawn Mower Housing (Includes Key Number 38)	27	193436	Torsion Spring
2	194177X421	Control Bar	28	193707	Blade Adapter
3	179585	Rope Guide	29	141114	22" Blade
4	194179X479	Upper Handle	30	851074	Hardened Washer
5	169708X479	Lower Handle	31	850263	Helical Lockwasher 3/8
6	73800400	Locknut, Hex 1/4-20	32	851084	Screw, Hex Head 3/8-24 x 1-3/8 (Grade 8)
7	191574	Handle Bolt 5/16-18	33	751153	Nut, Hex, Nylock 5/16-18
8	161622	Clip, Closeout	34	193083X479	Wheel Bracket Support, LH
9	160830	Plate, Mulcher	35	193082X479	Wheel Bracket Support, RH
10	132004	Locknut, Hex 1/4-20	36	160835X007	Wheel Bracket Adjuster
11	158152	Engine Zone Control Cable	37	160833	Hinge Rod
12	750634	Hex Washer Head Screw #10-24 x 1/2	38	107339X	Danger Decal
13	86899X004	Up-Stop Bracket	39	168360X004	Selector Spring
14	180409X004	Axle Arm Assembly, Rear, LH	40	170143	Selector Knob
15	186577X004	Axle Arm Assembly, Front, LH	41	150406	Hex Head Thread Rolling Screw 3/8-16 x 1
16	189713X421	Handle Knob	43	183901	Spacer
17	180410X004	Axle Arm Assembly, Rear, RH	44	160828	Shoulder Bolt 5/16-18
18	186578X004	Axle Arm Assembly, Front, RH	45	193926X421	Wheel & Tire Assembly, Rear, 12"
19	51793	Hairpin Cotter	46	83923	Nut, Hex, Flangelock 3/8-16
20	74760412	Screw, Hex Cap Head 1/4-20	47	193905X421	Wheel & Tire Assembly, Front, 8"
21	189008	Rear Deflector	48	74760514	Hex Head Bolt 5/16-18
22	66426	Wire Tie	51	88348	Washer, Flat
23	160831	Discharge Guard	52	197480	O-Ring
24	145212	Nut, Hex, Flangelock 3/8-16	53	192770	Clip, Cable
25	166785	Nut, Hex, Flangelock 5/16-18	--	162300	Warning Decal (not shown)
26	---	Engine, Briggs & Stratton, Model Number 123K02 (For engine service and replacement parts, call Briggs & Stratton at 1-800-233-3723)	--	193732	Operator's Manual, English
			--	193734	Operator's Manual, French
			--	196158	Repair Parts Manual, English / French

NOTE: All component dimensions given in U.S. inches. 1 inch = 25.4 mm.

IMPORTANT: Use only Original Equipment Manufacturer (O.E.M.) replacement parts. Failure to do so could be hazardous, damage your lawn mower and void your warranty.