

ROTARY LAWN MOWER - - MODEL NUMBER PR65Y21RKP (MFG. ID. NUMBER 96142002401)

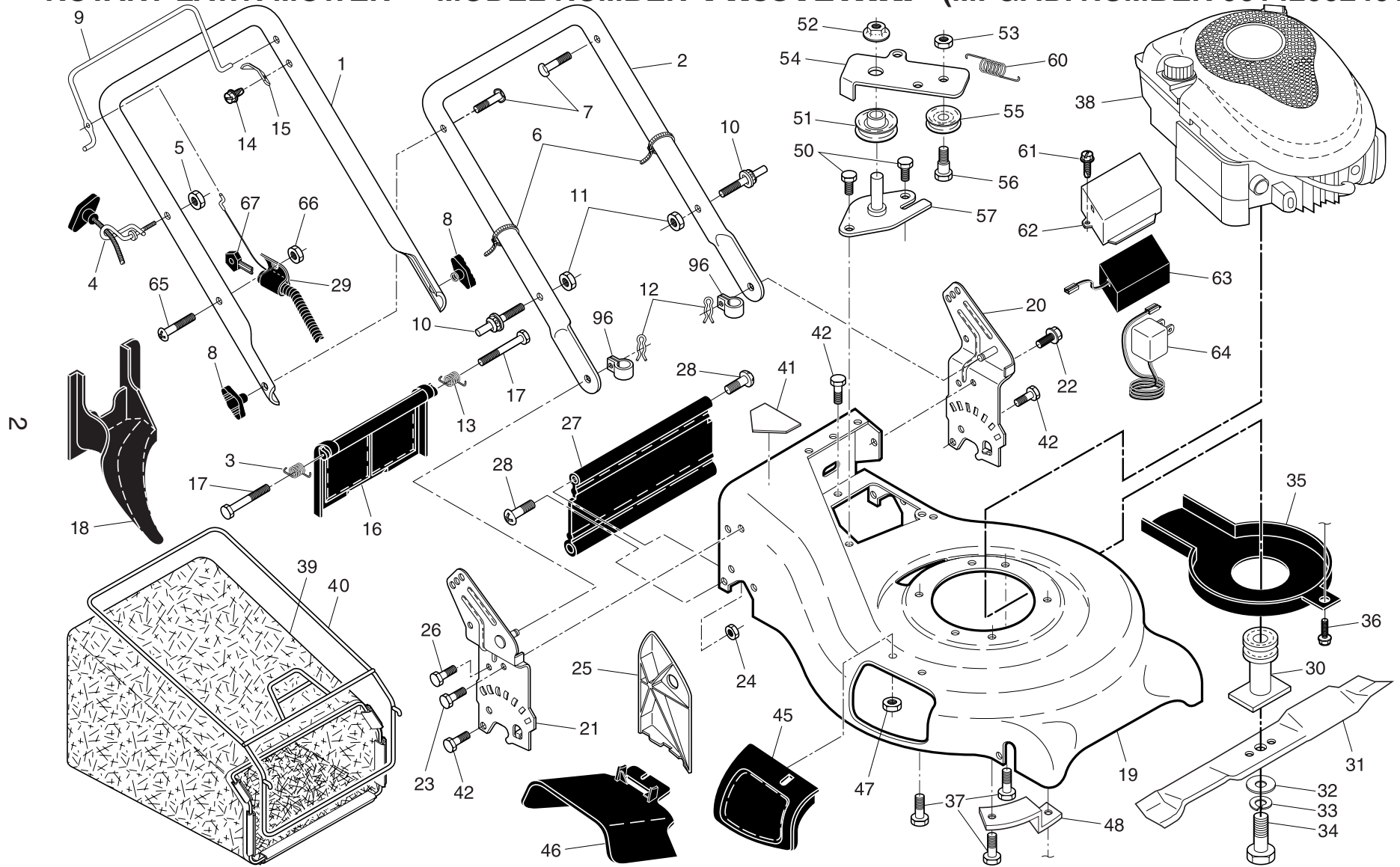

ROTARY LAWN MOWER - - MODEL NUMBER **PR65Y21RKP** (MFG. ID. NUMBER 96142002401)

KEY NO.	PART NO.	DESCRIPTION	KEY NO.	PART NO.	DESCRIPTION	KEY NO.	PART NO.	DESCRIPTION
1	194579X479	Handle, Upper	24	73800500	Nut, Hex, Lockwasher Insert	45	183058X428	Mulcher Door Assembly
2	193664X479	Handle, Lower			5/16-18	46	169699X428	Discharge Guard
3	186053	Spring, Rear Door, RH	25	161333	Baffle, Side	47	88349	Nut, Hex
4	194788	Rope Guide	26	163409	Screw #12 x 5/8	48	188839X004	Mounting Bracket, Debris Shield
5	132004	Nut, Hex, Lockwasher Insert 1/4-20	27	192876	Skirt, Rear			
6	66426	Wire, Tie	28	88652	Screw, Hinge 1/4-20 x 1.25	50	57808	Screw
7	191574	Bolt, Handle 5/16-18 x 2-5/8	29	194953	Key Switch /	51	193791	Pulley, Idler
8	189713X428	Knob, Handle	30	189179	Engine Zone Control Cable	52	145212	Flanged Nut
9	194580X428	Control Bar	31	189028	Blade Adapter / Pulley	53	155552	Locknut
10	188821	Bolt, Carriage	32	851074	Blade, 21"	54	193792X004	Idler Arm
11	73930500	Locknut, Hex 5/16-18	33	850263	Washer	55	166043	Idler Pulley
12	51793	Cotter, Hairpin	34	851084	Washer, Lock	56	160829	Shoulder Bolt
13	186052	Spring, Rear Door, LH	35	188786	Bolt, Hex Head	57	193315X004	Bracket Assembly
14	750634	Screw	36	192325	Debris Shield	60	182226	Spring, Return
15	850733X004	Bracket, Upstop	37	150406	Bolt	61	17411318	Screw
16	185855X428	Kit, Rear Door (Includes Springs)	38	- - -	Bolt, Engine	62	195743	Battery Box
17	184193	Bolt, Rear Door			Engine, Briggs & Stratton, Model Number 123K05 (For engine service and replacement parts, call Briggs & Stratton at 1-800-233-3723)	63	189589	Battery
18	198170	Plug, Mulcher				64	190097	Battery Charger
19	402487	Kit, Housing				65	186159	Screw
20	192980X479	Handle Bracket Assembly, LH				66	132004	Nut, Hex
21	192979X479	Handle Bracket Assembly, RH	39	402489	Grassbag	67	180331	Key
22	150078	Screw, Hex Washer Head	40	194644	Frame, Grassbag	96	197991	Clip, Cable
23	163183	Bolt, Hex Head 5/16-18 x 5/8	41	107339X	Danger Decal	- -	162300	Warning Decal (not shown)
			42	54583	Screw	- -	193733	Operator's Manual, English
						- -	193736	Operator's Manual, French
						- -	405930	Repair Parts Manual, English / French

NOTE: All component dimensions given in U.S. inches. 1 inch = 25.4 mm.

IMPORTANT: Use only Original Equipment Manufacturer (O.E.M.) replacement parts. Failure to do so could be hazardous, damage your lawn mower and void your warranty.

ROTARY LAWN MOWER - - MODEL NUMBER PR65Y21RKP (MFG. ID. NUMBER 96142002401)

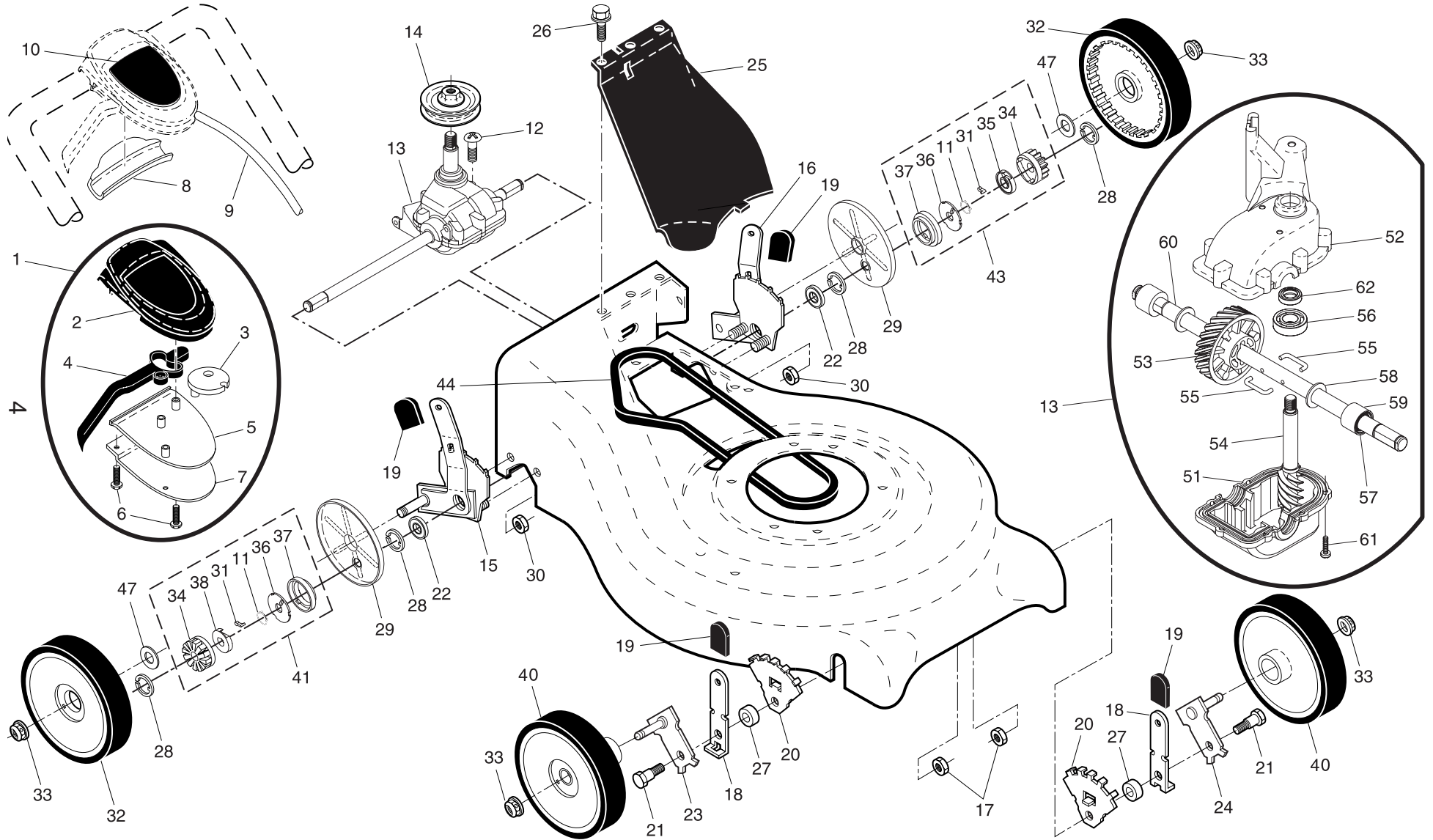

ROTARY LAWN MOWER - - MODEL NUMBER **PR65Y21RKP** (MFG. ID. NUMBER 96142002401)

KEY NO.	PART NO.	DESCRIPTION	KEY NO.	PART NO.	DESCRIPTION
1	402485	Drive Control Assembly (Includes Cable)	28	12000058	E-Ring 7/16
2	195745	Cover, Top	29	189403	Cover, Dust, Wheel
3	187353	Pulley	30	73800400	Nut, Hex
4	195585	Lever, Drive Control	31	175098	Pawl
5	195744	Cover, Bottom	32	193912X421	Wheel & Tire Assembly, Rear 8 x 1-3/4
6	181698	Screw	33	83923	Nut, Flangelock 3/8-16
7	400235X479	Mounting Bracket	34	175103	Gear
8	184987	Cap, Bottom	35	175105	Retainer, Drive, LH
9	196002	Cable, Drive	36	175104	Disc, Drive
10	195175	Decal, Drive Control	37	184172	Seal, Friction
11	188291	Spring, Torsion	38	175102	Retainer, Drive, RH
12	187653	Screw	40	193909X421	Wheel & Tire Assembly, Front 8 x 1-3/4
13	193354	Gear Case Assembly, Complete	41	188330	Pinion Assembly, RH
14	193443	Pulley, Drive	43	188331	Pinion Assembly, LH
15	197235	Kit, Wheel Adjuster Assembly, RH (Includes Knob and Bearing)	44	183688	V-Belt
16	197234	Kit, Wheel Adjuster Assembly, LH (Includes Knob and Bearing)	47	67725	Washer
17	166785	Nut, Hex	51	187530	* Case, Lower
18	168360X004	Spring, Selector	52	187531	* Case, Upper
19	87877	Knob, Selector Spring	53	187532	Gear, 24 Teeth
20	160835X007	Bracket, Wheel Adjusting	54	187533	Shaft, Input
21	160828	Bolt, Shoulder, Hex Head	55	183505	Wire, Formed
22	169911	Bearing, Ball	56	183506	Bearing, Ball
23	186578X004	Axle Arm Assembly, RH	57	183508	Seal, Output Shaft
24	186577X004	Axle Arm Assembly, LH	58	183509	Washer
25	199775X428	Cover Drive	59	183511	Bushing
26	750634	Screw, Threaded, Rolled #10-25 x .50	60	197385	Shaft, Output
27	183901	Spacer	61	183513	Screw
			62	183514	Seal, Input Shaft

* Use Dow Corning #709 to reseal Gear Case Halves.

NOTE: All component dimensions given in U.S. inches. 1 inch = 25.4 mm.

IMPORTANT: Use only Original Equipment Manufacturer (O.E.M.) replacement parts. Failure to do so could be hazardous, damage your lawn mower and void your warranty.