

ROPER REAR TINE TILLER--MODEL NUMBERS RT150FR AND RT150ET

MAIN FRAME

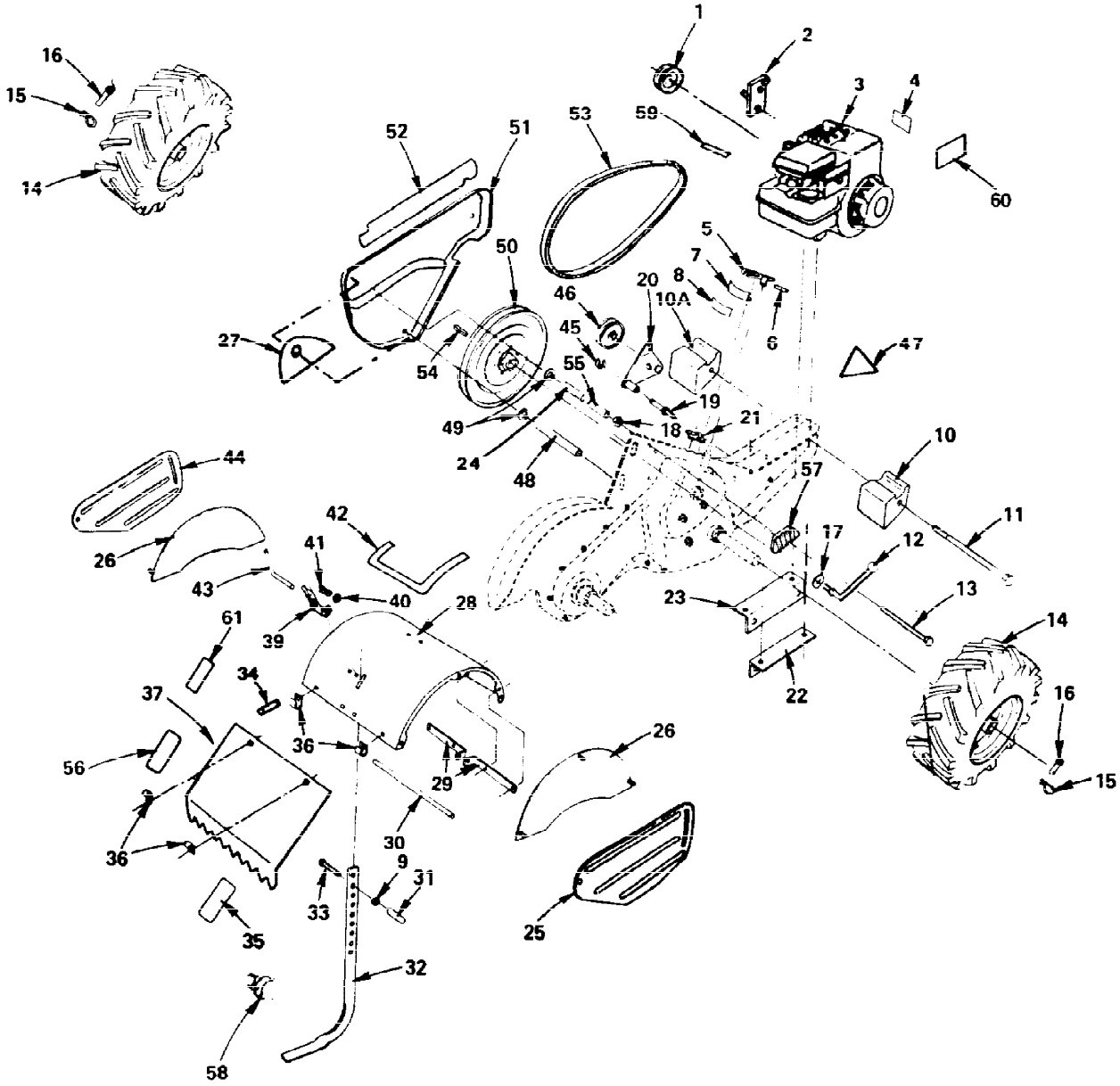









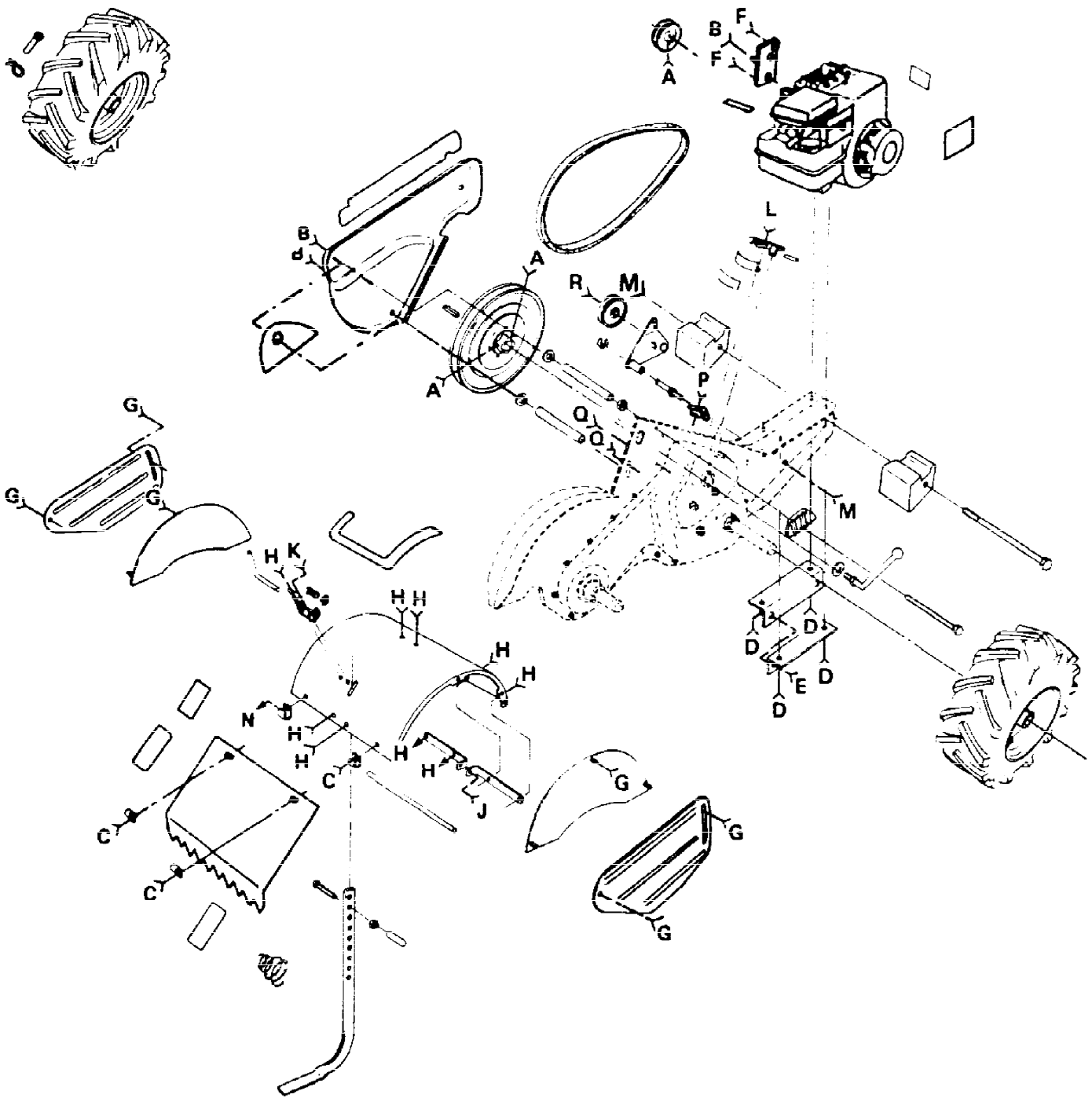

Ref #	Part Number	Qty	Description
1	102142X		SUB= 130816
2	102376X		BRACKET ASSY CRT
3	130202		NLA
4	102697X		DECAL - 5HP
5	110111X		LEVER ASM CRT
6	1572H		SUB= 2882J
7	8700J		PANEL TI
8	102180X		DECAL CRT
8	104323X		NLA
9	73220600		NUT.HEX.3/8-16UNC
10	102173X		COUNTERWEIGHT CRT
10A	102383X		COUNTERWEIGHT CRT
11	102384X		BOLT CRT
12	109228X		LEVER LOCK CRT
13	74930576		BOLT-HEX TI
14	102189X		SUB= 124258X
	102190X		TIRE.CHV.13X5.0-6
	795R		SUB= 65139
15	4497H		RETAINER M
16	102841X		SUB= 126875X
17	19131611		WASHER CRT
18	73220500		NUT.HEX.5/16-18
19	102141X		SHIFT ARM CRT
20	105611X		SUB= 918105611X
21	9484R		CONDIUT CLIP T
22	102332X		BRACKET RH CRT
23	102331X		BRACKET LH CRT
24	110652X		SPACER CRT
25	104101X388		SUB= 104101X505
26	104085X388		SHIELD CRT
27	110653X388		SUB= 110653X
28	102326X388		SUB= 102326X505
29	102155X		SUB= 124343X
30	102154X		SUB= 120588X
31	102701X		GRIP CRT
32	102156X		SUB= 102156X500
33	74930632		BOLT
34	6712J		VINYL CAP TI
35	120076X		SUB= 120075X
36	4440J		HINGE CRT
37	102695X388		SUB= 102695X505
38	110593X		SUB= 121858X
38	110612X		DECAL TI
39	8392J		LATCH BRACKET TI
40	12000036		KLIP RING TI
41	8394J		SPRING TI
42	102698X		DECAL - TINE SHIELD
43	8393J		STAKE PIN TI
44	104086X388		SHIELD.SD.OUT.LH
45	12000032		KLIP RING
46	104679X		PULLEY-IDLER TI
47	110596X		DECAL - OPEI
48	104370X		SPACER CRT

Ref #	Part Number	Qty	Description
49	19111116		WASHER
50	100473M		"SHEAVE 10"" CRT"
51	102148X388		SUB= 131159X505
52	102699X		NLA
53	102143X		SUB= 132672
54	2649M		KEY T
55	110651X		SPACER CRT
56	104949X		DECAL - DEPTH ADJUSTMENT
57	109299X		LOCK - HANDLE
58	109230X		SPRING CRT
61	109227X		PAD IDLER TI

ROPER REAR TINE TILLER--MODEL NUMBERS RT150FR AND RT150ET

MAIN FRAME



- | | | | | | | | | | |
|---|---|---|---|---|---|---|--|---|---|
| A | B | C | D | E | F | G | H | J | K |
|  |  |  |  |  |  |  |  |  |  |
| 1 | 3
4 | 5
6
7 | 8
9
10 | 11
12
13 | 6
7 | 16 | 17
9
10 | 18
9
10 | 19
9
10 |

Ref #	Part Number	Qty	Description
1	23230506		SET SCREW
3	19111116		WASHER
4	104214X		NUT TI
5	72140404		BOLT
6	10040400		LOCKWASHER
7	73220400		SUB= 50675
8	74760524		BOLT.HEX.5/16-1.5
9	10040500		LOCKWASHER
10	73220500		NUT.HEX.5/16-18
11	74760616		BOLT
12	10040600		LOCKWASHER
13	73220600		NUT.HEX.3/8-16UNC
16	98000129		NUT
17	72140505		BOLT
18	72110508		BOLT CRT
19	72140506		BOLT

ROPER REAR TINE TILLER--MODEL NUMBERS RT150FR AND RT150ET

MAIN FRAME

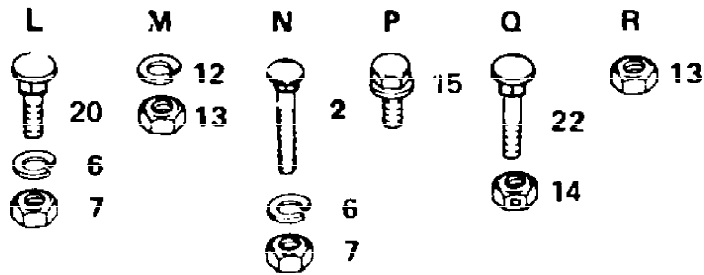

Ref #	Part Number	Qty	Description
2	72040410		BOLT
6	10040400		LOCKWASHER
7	73220400		SUB= 50675
12	10040600		LOCKWASHER
13	73220600		NUT.HEX.3/8-16UNC
14	5394H		SUB= 73930600
15	86777		SUB= 750097
20	72110404		BOLT
22	72110608		BOLT D

ROPER REAR TINE TILLER--MODEL NUMBERS RT150FR AND RT150ET

TRANSMISSION - GROUND DRIVE

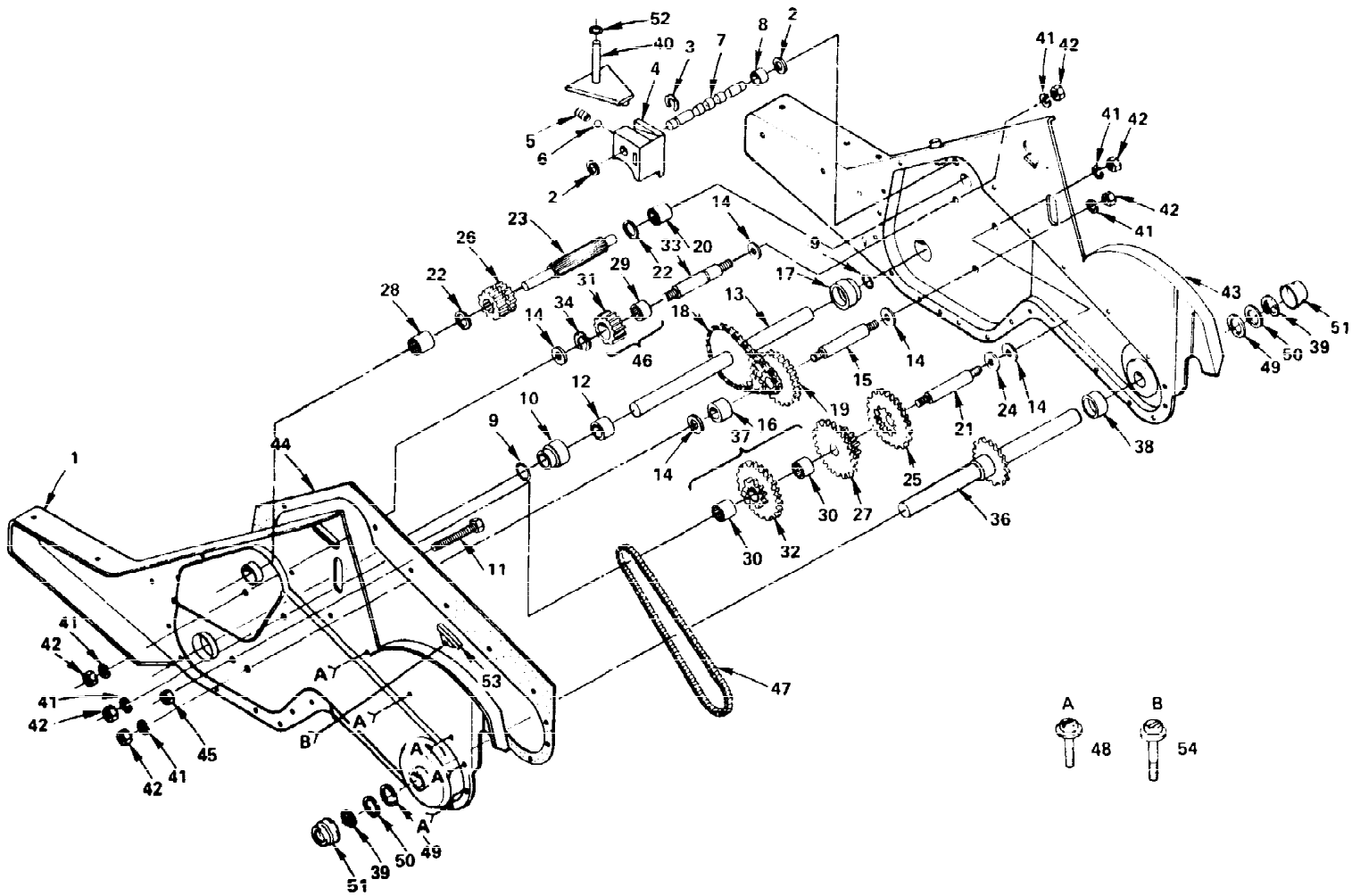

Ref #	Part Number	Qty	Description
	109203X		SUB= 155112
1	106549X		SUB= 150698
2	102136X		WASHER SEAL CRT
3	12000039		KLIP RING
4	8353J		SHIFT FORK TI
5	100371K		SPRING-SHIFT CRT
6	7392M		SUB= 100482K
7	102109X		SHAFT SHIFT CRT
8	104159X		SPACER SPLIT CRT
9	102128X		O RING CRT
10	102100X		"CRT, BEARING"
11	102101X		SCRW WHIZ LOK CRT
12	106390X		BUSHING TI
13	109204X		SUB= 150737
14	4358J		WASHER
15	102112X		SHFT 2ND RED. CRT
16	106388X		SPACER TI
17	102106X		SUB= 918102106X
18	102134X		CHAIN CRT
19	102121X		SPRCKT 8 GEAR CRT
20	4895H		"TI, BEARING"
21	8358J		REDUCTION SHFT TI
22	1370H		"T, BEARING"
23	102110X		SHAFT-INPUT CRT
24	4220R		BRNG RACE
25	105346X		GEAR TI
26	102113X		PINION-INPUT CRT
27	105345X		GEAR TI
28	5020J		NEEDLE BRNG LT
29	6803J		NEEDLE BEARING TI
30	4422J		BEARING
31	102115X		GEAR-REV IDLR CRT
32	106142X		SUB= 137300
33	102111X		SHAFT CRT
34	12000040		KLIP RING
36	106144X		SHAFT ASSY TI
37	106141X		SUB= 137300
38	106143X		SPACER
39	102144X		RING SPIRAL CRT
40	102107X		ARM ASSY CRT
41	10040700		LOCKWASHER
42	73610700		NUT.ASF.HEX.7/16
43	109297X		SUB= 150700
44	106211X		GASKET TI
45	73220500		NUT.HEX.5/16-18
46	102114X		GEAR ASSY CRT
47	106147X		CHAIN.50 LINK TI
48	17580408		SCREW CRT
49	9674R		SUB= 147344
50	9676R		SUB= 147344
51	9672R		CUP.FORMED.
52	106160X		O-RING TI
53	106212X		BLOCK TI

Ref #	Part Number	Qty	Description
54	17580410 6066J		SCREW TI GREASE PREMIUM-1
