

WEED EATER

® Trademark

ENGLISH



**Please do not return unit to retailer.
Por favor, no devuelva el aparato al lugar de compra.
Veuillez ne pas retourner l'outil au détaillant.**

1-800-554-6723

www.weedeater.com

Instruction Manual Manual de Instrucciones Manuel d'Instructions



**TWIST 'N EDGE®
CORDLESS**

ESPAÑOL



WARNING:

Read and follow all Safety Rules and Operating Instructions before using this product. Read instructions carefully before assembling. Failure to do so can result in serious injury.

ADVERTENCIA:

Lea el manual del operador y siga todas las advertencias e instrucciones de seguridad. Antes de ensamblar el producto lea cuidadosamente el instructivo. El no hacerlo puede resultar en lesiones graves.

AVERTISSEMENT:

Veuillez lire le manuel de l'utilisateur et bien respecter tous les avertissements et toutes les instructions de sécurité. Bien lire les instructions avant d'assembler l'outil. Tout défaut de le faire pourrait entraîner des blessures graves.

WEED EATER
1030 Stevens Creek Road
Augusta, GA 30907

WEED EATER
5855 Terry Fox Way
Mississauga, Ontario L5V 3E4

FRANÇAIS

545123824 Rev. 2 6/15/07 BRW

IDENTIFICATION OF SAFETY SYMBOLS

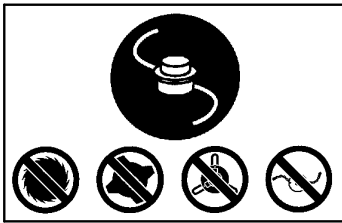

⚠ DANGER: Use only specified trimmer head, spool, and 0.065 inch (1.65 mm) recommended trimmer line. Never use blades, flailing devices, wire, rope, string, etc. Unit is designed for line trimmer use only. Failure to follow these instructions may result in serious injury.



⚠ WARNING: This unit can be dangerous! Careless or improper use can cause serious injury.



Read the operator's manual before use. Failure to follow instructions could result in serious injury. Save operator's manual.



To reduce the risk of electric shock, do not expose unit to water. Do not operate unit on wet ground or in rain.



Trimmer line can throw objects violently. You can be blinded or injured. Always wear hearing protection and safety glasses marked Z87. Always wear heavy, long pants, long sleeves, boots and gloves.

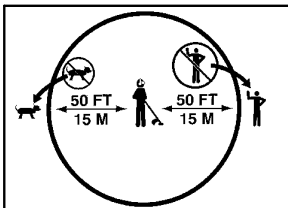

Hazard zone for thrown objects.

- Trimmer line throws objects violently.
- You and others can be blinded/injured.
- Keep children, bystanders, and animals 50 feet (15 meters) away.



Secure hair above shoulder length. Do not wear jewelry, loose clothing, or clothing with loosing hanging straps, ties, tassels, etc. They can be caught in moving parts.

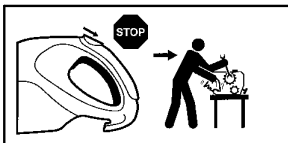

Stop unit before cleaning or servicing. Keep hands and fingers away from the trigger switch to avoid accidental starting during cleaning or servicing.

IDENTIFICATION OF SAFETY SYMBOLS

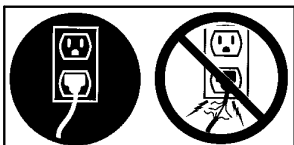

Do not use with damaged cord. Repair or replace damaged cord immediately.

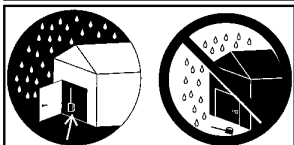

Store unit indoors in a high, dry place out of the reach of children. Store unit unplugged.



This unit is for household use only and not for commercial use.



When servicing unit, use only identical replacement parts.

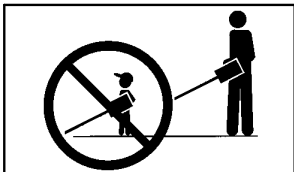

Never allow children to operate this unit.

SAFETY RULES

WARNING: When using electric gardening appliances, basic safety precautions must always be followed to reduce the risk of fire, electric shock, and serious injury. Read and follow all instructions.



SAFETY INFORMATION
ON THE UNIT

This power unit can be dangerous! Operator is responsible for following the warnings and instructions in this manual and on the unit. Read entire instruction manual before using unit! Be thoroughly familiar with the controls and the proper use of the unit. Restrict the use of this unit to persons who read, understand, and follow unit and manual warnings and instructions. Never allow children to operate this unit. Close attention is necessary when used near children.

DANGER: Never use blades or flailing devices. Unit is designed for line trimmer use only. Use of any other accessories or attachments will increase the risk of injury.



WARNING: Trimmer line throws objects violently. You and others can be blinded/injured. Wear safety glasses, boots, and leg protection. Keep body parts clear of rotating line. Keep children, bystanders, and animals 50 feet (15 meters) away. If approached stop unit immediately. If situations occur which are not covered in this manual, use care and good judgement. If you need assistance, call 1-800-554-6723.

OPERATOR SAFETY

- Dress properly. Always wear safety glasses or similar eye protection when operating, or performing maintenance on your unit. (Safety glasses are available.) Always wear face or dust mask if operation is dusty. Always wear heavy, long pants, long sleeves, boots, and gloves. Do not go barefoot or wear sandals.
- Secure hair above shoulder length. Secure or remove loose clothing and jewelry or clothing with loosely hanging ties, straps, tassels, etc. They can be caught in moving parts.
- Being fully covered also helps protect you from debris and pieces of toxic plants thrown by spinning line.
- Stay alert. Do not operate unit when you are tired, ill, upset or under influence of alcohol, drugs, or medication. Watch what you are doing; use common sense.
- Avoid unintentional starting of the unit. Keep hands and fingers away from the trigger switch while carrying the unit.

ELECTRICAL SAFETY

⚠ WARNING: Avoid a dangerous environment. To reduce the risk of electrical shock, do not use on wet grass. Do not use in rain, in damp or wet locations, or around swimming pools, hot tubs, etc. Do not expose to snow, rain, or water to avoid the possibility of electrical shock.

- Only use the charger provided with your unit when charging the battery. Use of any other charger could permanently damage the battery, charger, and/or the unit.
- Use charger with standard household electrical outlets only (120 volt). Do not abuse the charger or charger cord. Never carry the unit by the charger cord or yank cord to disconnect from receptacle. Do not use the charger if the charger or charger cord is damaged.
- Use the charger indoors only.
- Store and charge this unit in a dry location and out of the reach of children.
- Avoid dangerous situations. Do not charge the battery or use the unit in an explosive or corrosive environment. Avoid areas where flammable liquids or gases are present to avoid creating a fire or explosion and/or causing damage to unit.
- Do not operate unit while it is attached to the charger.
- Do not attempt to repair unit, battery or charger. Inspect insulation and connectors on the unit and charger before each use. If there is any damage, do not use until damage is repaired by your authorized service dealer.
- Do not insert any object into the motor area.
- Battery-powered units do not have to be plugged into an electrical outlet to operate; therefore, they are always in operating condition. Be aware of possible hazards when you are not using your battery-powered unit.
- Do not dispose of the battery in a fire. The cell may explode. Check with local code for proper disposal. Do not open or mutilate the battery. Released electrolyte is corrosive and

may cause damage to the eyes or skin. It may be toxic if swallowed.

- When handling batteries, take care not to short the battery with conducting materials such as rings, bracelets, and keys. The battery or conductor may overheat and cause burns.
- Do not use the unit if the trigger switch does not turn the unit on and off properly. Repairs to the switch must be made by your authorized service dealer.
- Never immerse any part of the unit or charger into any liquid.
- Inspect charger cord periodically and if damaged, have it repaired or replaced by an authorized service dealer.
- Disconnect charger from receptacle when not in use to reduce the risk of electric shock or serious personal injury.

UNIT SAFETY

- Inspect unit before use. Replace damaged parts. Make sure all handles, guards, and fasteners are in place and securely fastened. Parts that are damaged must be repaired or replaced by an authorized service dealer. These include head parts that are cracked, or chipped, guards, and any other part that is damaged.
- Do not repair unit yourself.
- Use only 0.065 inch (1.65 mm) diameter recommended trimmer line (see USER REPLACEABLE SERVICE PARTS in the SERVICE AND ADJUSTMENTS section). Never use wire, rope, string, etc.
- Use specified trimmer spool. Make sure spool is properly installed and all parts are securely fastened.
- Use only WEED EATER replacement parts and accessories as recommended.

CUTTING SAFETY

⚠ WARNING: Inspect area to be cut. Remove objects (rocks, broken glass, nails, wire, string, etc.) which can be thrown or become entangled in cutting head.

- Do not overreach or stand on unstable support. Keep firm footing and balance.
- Keep the cutting head below waist level. Do not raise handles above your waist. Cutting head can come dangerously close to your body.
- Keep away from cutting head and spinning line.
- Use unit properly. Use only for trimming, scalping, and mowing. Do not force unit. It will do the job better and with less risk of injury at the rate for which it was designed.
- Use only in daylight or in good artificial light.

MAINTENANCE SAFETY

⚠ WARNING: Stop unit before performing maintenance. Keep hands and fingers away from the trigger switch to avoid accidental starting during maintenance, or when changing trimmer line.

- Maintain unit according to recommended procedures. Keep cutting line at proper length. Follow instructions for changing trimmer line.

- Have all service and maintenance not explained in this manual performed by an authorized service dealer to avoid creating a hazard.
- Never douse or squirt the unit with water or any other liquid. Clean unit and labels with a damp sponge. Keep handles dry, clean, and free from oil and grease.
- Keep the air vents clean and free of debris to avoid overheating the motor. Clean after each use.

TRANSPORTING AND STORAGE

- Stop the unit and place in wall bracket for storage and battery charging.
- Carry the unit with motor stopped.
- Store unit indoors in a high, dry place out of the reach of children.
- Do not hang unit so that the trigger switch is depressed.

BATTERY CARE

- If over a period of time the battery quickly runs down after a full 24 hour charging period, a replacement battery is needed.
- There will be some charge present in the battery, but to ensure maximum running time, recharge your battery for 24 hours before use.
- Permanent connection to the charger in a well-ventilated area will automatically keep your battery fully charged and ready for use.

- To prevent permanent battery damage, never store in a discharged condition.

Battery

Sealed for Life
No maintenance required

Battery replacement

Should your battery need to be replaced, contact your authorized service dealer for a replacement battery and for proper disposal of the old battery.

WINTER STORAGE

- Fully charge for 24 hours before winter storage.
- If you are unable to leave your cordless trimmer on permanent charge, recharge the battery every 3 to 4 months for a full 24 hour charging period to fully charge the battery during winter storage.
- Avoid extended storage without recharge.
- Store in a cool dry place.

IMPORTANT!

DISPOSE OF YOUR OLD BATTERIES SAFELY. TAKE THE COMPLETE UNIT TO YOUR AUTHORIZED SERVICE DEALER. DO NOT CUT OPEN, BURN OR INCINERATE.

SAVE THESE INSTRUCTIONS

ASSEMBLY

WARNING: If received assembled, review all assembly steps to ensure your unit is properly assembled and all fasteners are secure.

SHAFT ASSEMBLY

WARNING: Ensure that the excess wire between the switch handle and motor housing is not twisted and is enclosed in switch handle and motor housing during assembly of the unit. Failure to do so may result in damage to the wires and/or the unit or serious injury to the operator.

1. Push the tube into the switch handle until it snaps into place.

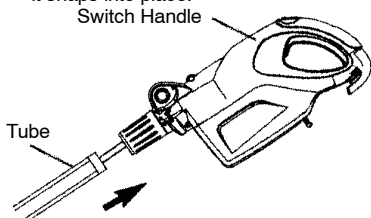

2. Push the tube into the motor housing until it snaps into place.

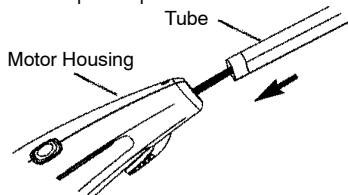

3. Try to remove tube from switch handle and motor housing. If the tube remains in place, it is properly snapped into place. If the tube will not remain in place, repeat steps 1 and 2. Push until the tube snaps into place.

ATTACHING THE SHIELD

WARNING: The shield must be properly installed. The shield provides partial protection from the risk of thrown objects to the operator and others. Your unit is equipped with a line limiter pin, which cuts excess line to the proper length while running.

NOTE: If shield is not properly installed, damage to unit (including motor failure) will result.

1. Place the shield onto the motor housing. Ensure the cutting head remains free to rotate and the line is not caught between the shield and the motor housing (see illustration).

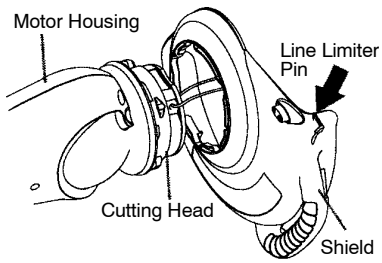

2. Align the installation arrow on the shield with the installation arrow on the motor housing as shown.

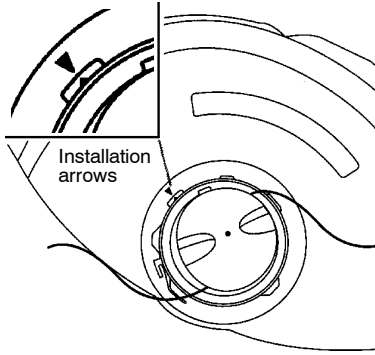

3. Twist the shield as illustrated until it snaps securely into place. Make sure the shield is assembled to the unit as shown in the illustration below and in the KNOW YOUR TRIMMER section of this manual.

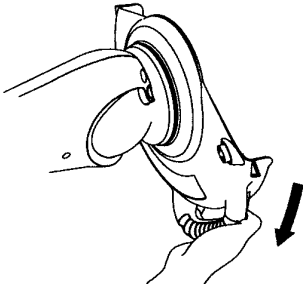

WHEEL ASSEMBLY

1. Fit the two halves of the wheel together (see illustration).

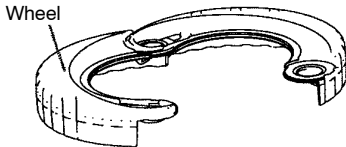

2. Attach the wheel to the trimmer. Make sure the wheel is fitted into the groove on the motor housing.

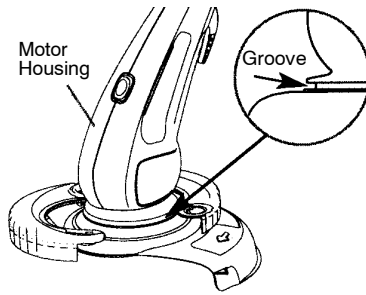

3. Clip the wheel together securely on the other side. The wheel should turn freely.

INSTALLATION OF ASSIST HANDLE

1. Press the two buttons on the sides of the switch handle.

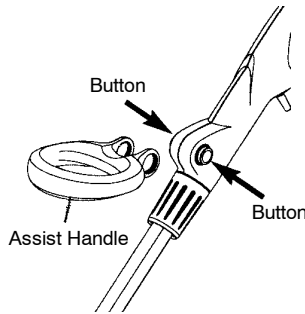

2. Push the assist handle over the buttons and release the buttons.
3. Adjust the handle to the most comfortable operating position by pressing the buttons and moving the handle.

ATTACHING THE SHOULDER STRAP

1. Fasten the shoulder strap hook to the retainer on the switch handle.

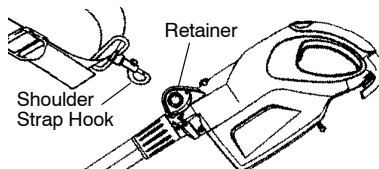

2. Adjust as required to ensure the shoulder strap is in the most comfortable position.

HEIGHT ADJUSTMENT

1. Turn height adjuster in the direction indicated to unlock (see illustration).

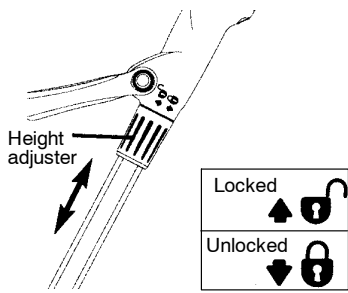

2. Adjust the length of the tube to the most comfortable operating position.
3. Turn height adjuster in the opposite direction to lock.

INSTALLATION OF THE WALL BRACKET

WARNING: Mount the wall bracket on a smooth, vertical and internal wall. The wall chosen must be strong enough to hold the weight of the bracket and the unit. Choose a location where the unit and wall bracket are not likely to be disturbed by children or passersby.

IMPORTANT! Unplug the charger from the electrical outlet before connecting or disconnecting the trimmer to the wall bracket.

1. Mount the wall bracket in a well ventilated area between 40°F (5°C) and 78°F (25°C).
2. There are three mounting holes on the wall bracket. Position the wall bracket with the two holes at the top.

Wall Bracket

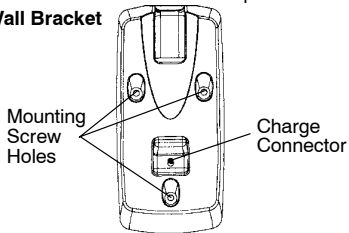

3. Ensure that when the trimmer is hung in the wall bracket, the bottom of the trimmer is within 4 inches (100 mm) of the ground. This will make it easier to hang the trimmer for charging and will also ensure that the wall bracket is within easy reach of an electrical outlet for plugging in the charger.

4. Mount wall bracket securely to the wall with the anchors and screws provided.

CAUTION: When drilling holes, avoid electrical wires in the wall and penetrating completely through the wall.

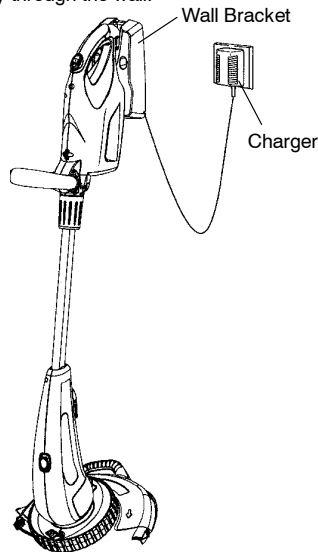

5. Your cordless trimmer can now be attached to the wall bracket for charging.

OPERATION

KNOW YOUR TRIMMER

READ THIS INSTRUCTION MANUAL AND SAFETY RULES BEFORE OPERATING YOUR UNIT. Compare the illustrations with your unit to familiarize yourself with the location of the various controls and adjustments. Save this manual for future reference.

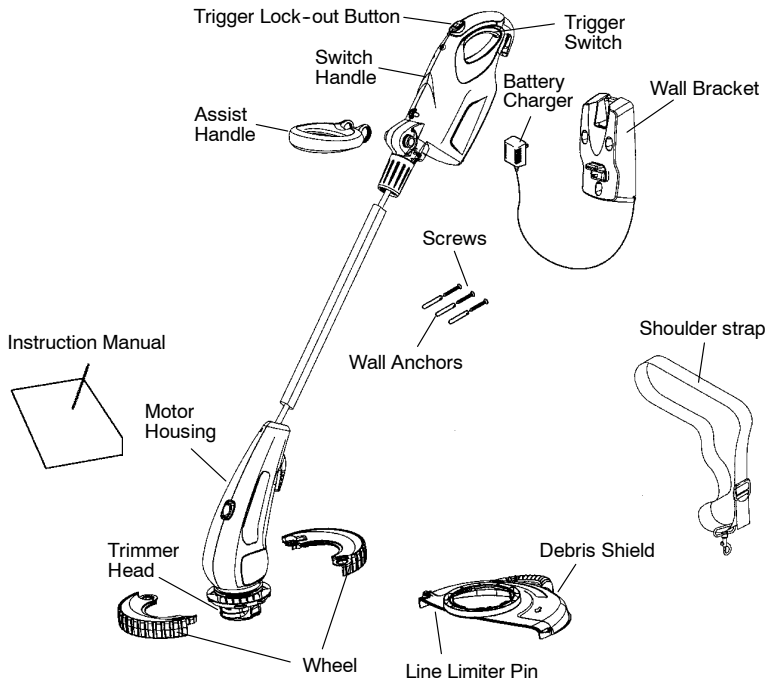

TRIGGER SWITCH

The TRIGGER SWITCH is used to turn on the unit. Squeeze the trigger switch to operate the unit. Release to stop.

TRIGGER LOCK-OUT BUTTON

The TRIGGER LOCK-OUT button is a control feature designed to prevent the motor from being accidentally started. When the switch handle is gripped in a normal cutting position, the trigger lock-out button can be pushed forward by the thumb, permitting the

index finger to squeeze the trigger switch. It is not necessary to maintain pressure on the trigger lock-out button once the trigger switch has been engaged.

LINE LIMITER PIN

The LINE LIMITER PIN cuts the cutting line to the proper cutting length.

TRIMMER HEAD

The TRIMMER HEAD holds cutting line and rotates during operation.

CHARGING YOUR UNIT

WARNING: Never charge battery in an explosive or corrosive environment. Avoid areas where flammable liquids or gasses are present to avoid creating a fire or explosion.

- Only use the charger provided with your unit when charging the battery. Use of any other charger could permanently damage the battery and/or the trimmer.
- Use the charger with standard household electrical outlets only. See the voltage specifications on the charger.

- Ensure the charger is not exposed to moisture. Keep the charger and the trimmer dry at all times.
- Keep the charger well ventilated during charging. Do not place the charger in an area of extreme heat or cold. It will work best at normal room temperature.
- Use the charger indoors only.
- The battery should be charged for 24 hours before use.
- Recharge the battery immediately after every use for the full 24 hour charging period.

- Charge continuously when not in use. Continuous charging will not damage the battery. The charger will automatically keep the battery charged and ready for use during storage.
- During charging, the charger becomes warm. This is normal and means the charger is operating correctly.

TO CHARGE YOUR UNIT:

1. Place the trimmer in the wall bracket.
2. Plug the charger into a standard household electrical outlet.
3. When properly connected, the red charge indicator light (LED) will glow.

NOTE: The red charge indicator light (LED) on the charger glows continuously during charging.

4. The battery will be fully charged in 24 hours.

RECHARGING YOUR UNIT

- Recharge the battery as soon as the cutting power of your cordless trimmer is no longer effective.
- Avoid running the battery into full discharge, i.e. avoid draining the battery completely.
- Follow the procedure outlined in the CHARGING YOUR UNIT section.
- Recharging the battery according to these instructions should ensure maximum battery life.
- Do not recharge the battery in an area of extreme heat or cold. It will work best at normal room temperature.

CORRECT OPERATING POSITION



Trimming



Edging

⚠ WARNING: Always wear eye protection. Never lean over the trimmer head. Rocks or debris can ricochet or be thrown into eyes and face and cause blindness or other serious injury.

When operating unit, stand as shown and check for the following:

- Wear eye protection and heavy clothing.

- Hold trigger handle with right hand and assist handle with left hand.
- Keep unit below waist level.
- Cut only from your right to your left to ensure debris is thrown away from you. Without bending over, keep line near and parallel to the ground and not crowded into material being cut.

AUTOMATIC LINE FEED SYSTEM

When the trimmer is initially started, a small length of cutting line is fed out.

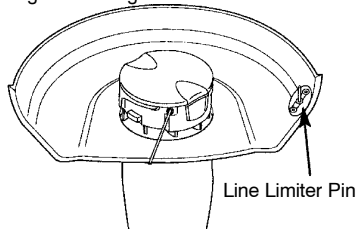

Line Limiter Pin

After approximately 5 seconds, the line will be cut to the correct length by the line limiter pin as the motor reaches full speed. **Make sure the motor is up to full speed before trimming.** If the noise of the cutting line being cut cannot be heard, more line will need to be fed out.

To feed more line:

- Allow the motor to stop completely; then, restart the motor and allow it to reach full speed.
- Repeat until you hear the line hitting against the line limiter pin (do not repeat this procedure more than 6 times).

If problems are experienced with the automatic line feed, refer to the TROUBLESHOOTING TABLE.

To manually feed the nylon line:

- If required, the cutting line can be fed out manually.
- To operate, press and release manual line feed button while gently pulling on one of the line until it reaches the line limiter pin.

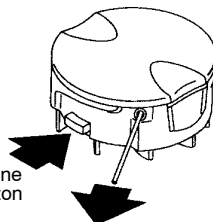

Manual Line Feed Button

- If the line extends past the line limiter pin, too much line has been fed out. If too much line is fed out, remove the spool cap and click spool counterclockwise until the line is at the desired length.

To remove spool cap:

1. Press and hold in the two cap release latches.
2. Pull cap away from the hub.

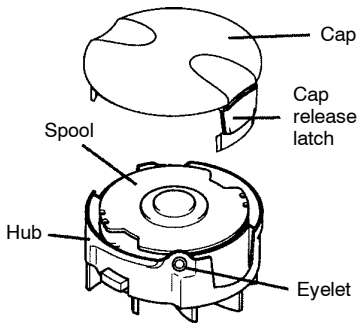

To reinstall spool cap:

1. Keep all areas of the cap and hub clean. Failure to do so may prevent the cap being securely located in the hub.
2. Replace the cap, pressing firmly down towards the hub to ensure cap is fully secured.
3. Check that the cap is secure by trying to remove it without pressing the two latches.

⚠ WARNING: Use only 0.065 inch (1.65 mm) diameter line. Other sizes of line will not advance properly and will result in improper cutting head function or can cause serious injury. Do not use other materials such as wire, string, rope, etc. Wire can break off during cutting and become a dangerous missile that can cause serious injury. See page 3 for warning concerning other cutting devices.

TRIMMING

Hold the bottom of the trimmer head about 3 inches (8 cm) above the ground and at an angle. Allow only the tip of the line to make contact. Do not force trimmer line into work area.

Trimming

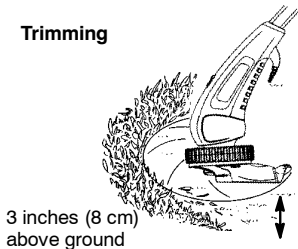

EDGING POSITION

You can twist the lower portion of the unit into an edging position. Press button and twist lower portion of unit as shown in the illustration until it snaps into place. To return to trimming position, press button and twist lower portion in opposite direction.

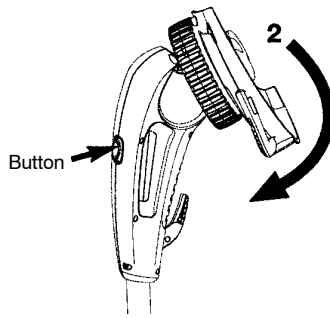

EDGING

While edging, allow unit to rest on wheel for extra stability. Edge in direction shown in illustration. Allow the tip of the line to make contact. Do not force the line. Take extra caution while edging as objects can be thrown from the trimmer line.

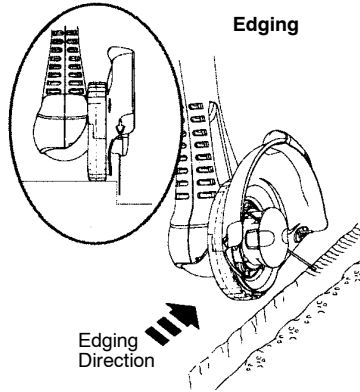

SCALPING

The scalping technique removes unwanted vegetation down to the ground. Hold the bottom of the trimmer head about 3 inches (8 cm) above the ground and at an angle. Allow the tip of the line to strike the ground around trees, posts, monuments, etc. This technique increases line wear.

Scalping

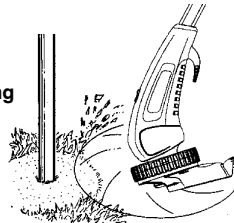

MOWING

Your trimmer is ideal for mowing in places conventional lawn mowers cannot reach. In the mowing position, keep the line parallel to the ground. Avoid pressing the head into the ground as this can scalp the ground and damage the tool.

Mowing

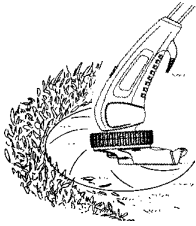

Sweeping

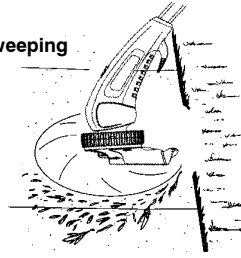

SWEEPING

The fanning action of the rotating line can be used for a quick and easy clean up. Keep the line parallel to and above the surfaces being swept and move the tool from side to side.

MAINTENANCE

⚠ WARNING: Keep hands and fingers away from the trigger switch to avoid accidental starting during maintenance.

GENERAL RECOMMENDATIONS

The warranty on this unit does not cover items that have been subjected to operator abuse or negligence. To receive full value from the warranty, the operator must maintain unit as instructed in this manual. Various adjustments will need to be made periodically to properly maintain your unit.

BEFORE EACH USE

CHECK FOR LOOSE FASTENERS AND PARTS

- Housing Screws
- Debris Shield

CHECK FOR DAMAGED OR WORN PARTS

Contact an authorized service dealer for replacement of damaged or worn parts.

- Trigger Switch - Ensure switch functions properly by pressing and releasing the trigger switch. Make sure motor stops.
- Debris Shield - Discontinue use of unit if debris shield is damaged.

AFTER EACH USE

INSPECT AND CLEAN UNIT AND LABELS

- After each use, inspect complete unit for loose or damaged parts. Never use a damaged trimmer.
- Clean the unit using a damp cloth with a mild detergent.
- Wipe off unit with a clean dry cloth.
- Use a soft brush to clean around the inside of the debris shield, the cutting head and the motor housing air vents.

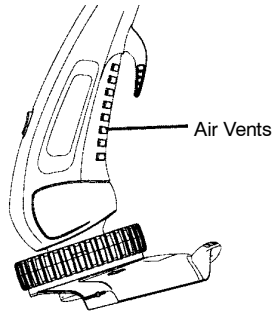
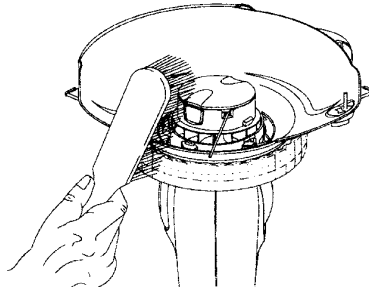

- Remove the wheel by pressing one of the buttons. Clean the wheel and groove on the motor housing with a soft brush. Reinstall wheel (see ASSEMBLY section).

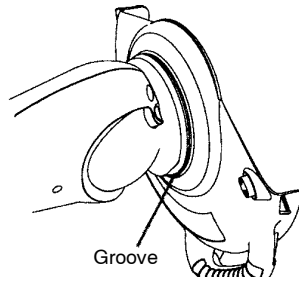
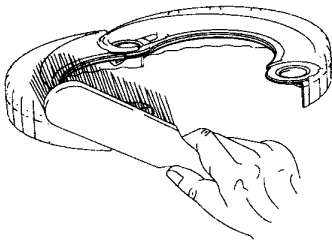

SERVICE AND ADJUSTMENTS

REPLACING THE LINE

⚠ WARNING: Keep hands and fingers away from the trigger switch to avoid accidental starting during service.

1. Press and hold in the two cap release latches.
2. Pull cap away from the hub.

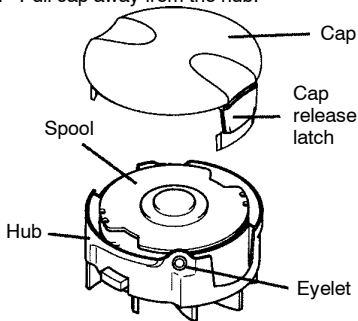

3. Remove old spool.
4. Clean entire surface of hub and spool.
5. Replace with a pre-wound spool or cut a length of 26 feet (8 meters) of 0.065" (1.65 mm) diameter WEED EATER brand line. Use of heavier lines could overload and damage unit.

⚠ WARNING: Never use wire, rope, string, etc., which can break off and become a dangerous missile.

6. Insert end of line about 1/2 inch (1 cm) into small hole on the inside of the spool.

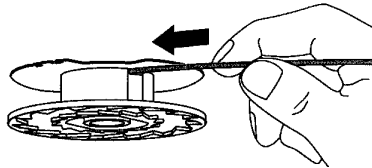

7. Wind the line evenly and tightly onto the spool. Wind in the direction of the arrow found on the spool.
8. Push the line into the notch, leaving 3 to 5 inches (7 - 12 cm) unwound.

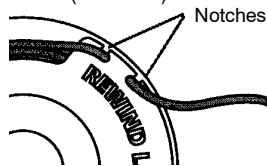

9. Place spool into hub with cut out area of spool in line with eyelet (see illustration).

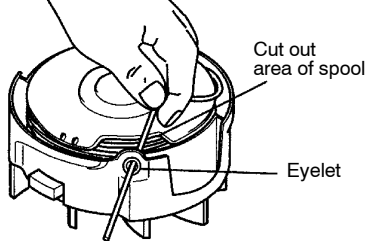

10. Remove line from notch and feed line through eyelet.
11. Reinstall the spool cap.

USER REPLACEABLE SERVICE PARTS

REPLACEMENT PART	SERVICE PART NUMBER
Spool with 0.065" Trimmer Line	545124406
Spool Cap	545124417
Assist Handle	545124407
Wheel	545124409
Battery (authorized distributor replacement item)	545124412
Charger GPE181-12120	545124410
Wall Mount Bracket	545124411

STORAGE

WARNING: Perform the following steps after each use.

- Stop the unit and place in wall bracket for storage and battery charging.
- Carry the unit with motor stopped.

- Store unit in a high, dry place out of the reach of children.
- Store unit with all guards in place. Position unit so that any sharp object cannot accidentally cause injury.

TROUBLESHOOTING TABLE

WARNING: Always stop unit before performing all of the recommended remedies below except remedies that require unit to be operating. Keep hands and fingers away from the trigger switch to avoid accidental starting.

TROUBLE	CAUSE	REMEDY
Trimmer head stops under a load or does not turn when switch is pressed.	<ol style="list-style-type: none"> 1. Crowding trimmer line against material being cut. 2. Battery needs charging. 3. Debris stopping head. 	<ol style="list-style-type: none"> 1. Allow tip of line to do the cutting. 2. Charge battery. 3. Remove debris.
Line does not advance, line is too short, or trimmer vibrates.	<ol style="list-style-type: none"> 1. Line improperly routed in head. 2. Line improperly wound into spool. 3. Incorrect line size 4. Not enough line outside of head. 5. Manual line feed not working. 6. Dirt buildup on unit. 	<ol style="list-style-type: none"> 1. Check line routing. 2. Rewind line tightly and evenly. 3. Use only 0.065 in. (1.65 mm) dia. line. 4. Remove spool cap and spool. Manually feed line. Reinstall cap and spool. See Automatic Line Feed System section. 5. Rewind line tightly and evenly. Check that line is in correct section of spool. 6. Clean unit.
Excessive noise when unit is running.	<ol style="list-style-type: none"> 1. Motor has not reached full speed before use. 2. Too much line has been released from the spool. 3. Line limiter pin missing from shield. 	<ol style="list-style-type: none"> 1. Allow the motor to reach full speed before use. 2. Rewind line tightly and evenly. See Automatic Line Feed System section. 3. Contact your authorized service dealer.
Line releases continuously.	<ol style="list-style-type: none"> 1. Line improperly routed in head. 2. Spool damaged. 	<ol style="list-style-type: none"> 1. Check line routing. 2. Replace spool.
Line usage is excessive.	<ol style="list-style-type: none"> 1. Line improperly routed in head. 2. Line size is incorrect. 3. Crowding line against material being cut. 4. Spool worn or damaged. 	<ol style="list-style-type: none"> 1. Check line routing. 2. Replace spool. 3. Cut with tip of line fully extended. 4. Replace spool.
Wheel stops turning.	<ol style="list-style-type: none"> 1. Dirt or debris buildup on wheel or in groove. 	<ol style="list-style-type: none"> 1. Clean wheel and groove on motor housing (see Maintenance section).

LIMITED WARRANTY

WEED EATER warrants to the original purchaser that each new **WEED EATER** brand electric or cordless product is free from defects in material and workmanship and agrees to repair or replace under this warranty any defective **WEED EATER** brand electric product within two (2) years from the original date of purchase.

If your **WEED EATER** brand electric or cordless product should fail within the limited warranty period, return it, complete, prepaid, with proof of purchase, to the dealer from whom it was purchased for repair or replacement at the option of **WEED EATER**.

This warranty is not transferable and does not cover damage or liability caused by improper handling, improper maintenance or the use of accessories and/or attachments not specifically recommended by **WEED EATER** for this electric product. Additionally, this warranty does not cover parts that will wear and require replacement with reasonable use during the warranty period. This warranty does not cover pre-delivery set-up or normal adjustments explained in the instruction manual.

THIS WARRANTY GIVES YOU SPECIFIC LEGAL RIGHTS, AND YOU MAY HAVE OTHER RIGHTS WHICH VARY FROM STATE TO STATE.

NO CLAIMS FOR CONSEQUENTIAL OR OTHER DAMAGES WILL BE ALLOWED, AND THERE ARE NO OTHER EXPRESS WARRANTIES EXCEPT THOSE EXPRESSLY STIPULATED HEREIN.

SOME STATES DO NOT ALLOW LIMITATIONS ON HOW LONG AN IMPLIED WARRANTY LASTS OR THE EXCLUSION OR LIMITATIONS OF INCIDENTAL OR CONSEQUENTIAL DAMAGES, SO THE ABOVE LIMITATIONS OR EXCLUSION MAY NOT APPLY TO YOU.

The policy of **WEED EATER** is to continuously improve its products. Therefore, **WEED EATER** reserves the right to change, modify, or discontinue models, designs, specifications, and accessories of all products at any time without notice or obligation to any purchaser.