

same as 944.606191

TRACTOR -- MODEL NUMBER 917.252521

MOWER DECK

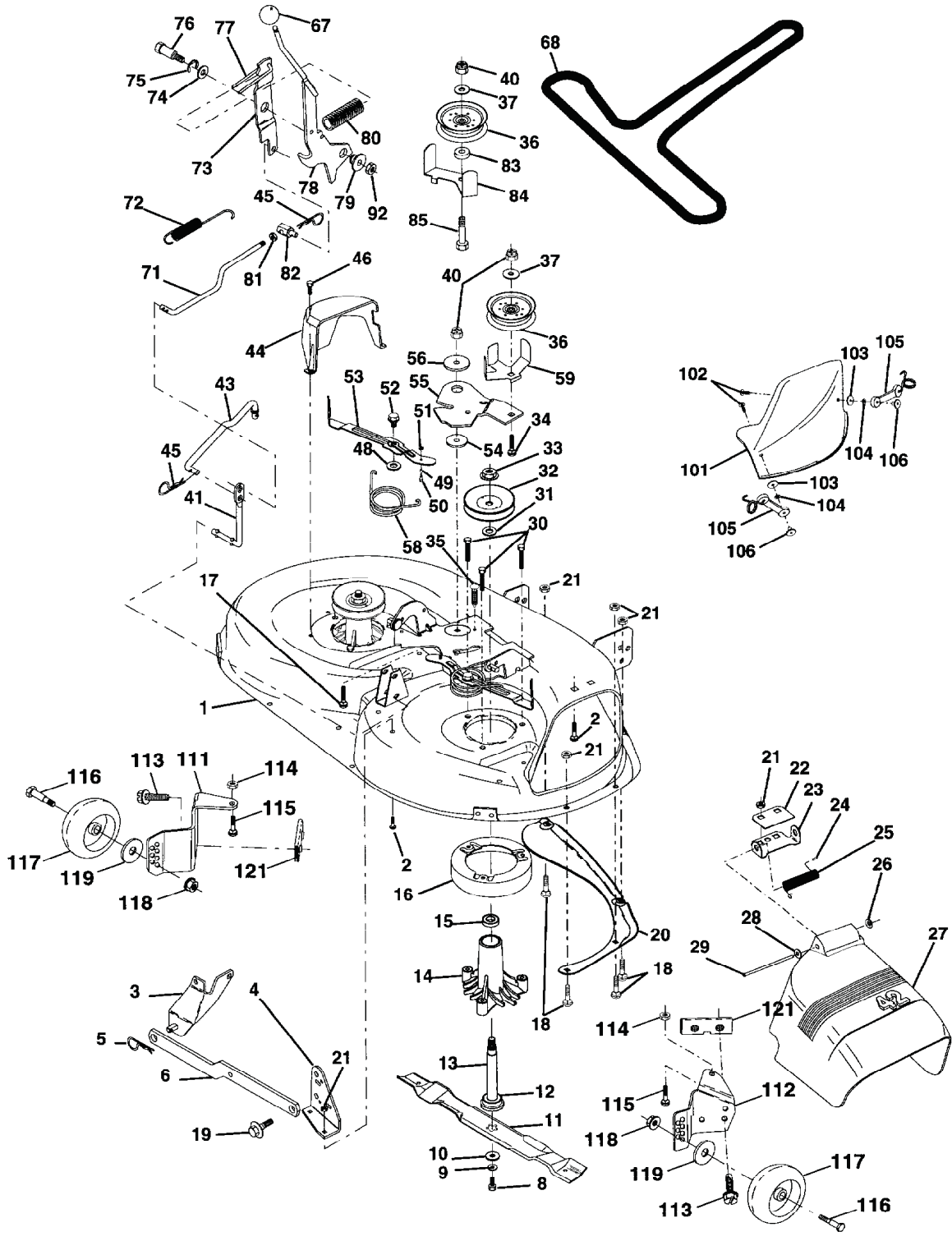

Ref #	Part Number	Qty	Description
1	144393		DECK.WELD.42.
2	STD533107		BOLT
3	138017		BRKT ASM SWAY BAR
4	138440		BRKT DECK SW BAR
5	STD624008		RETAINER RING
6	130832		SUB= 130833
8	850857		BLADE BOLT
9	STD551137		WASHER, LOCK
10	140296		WASHER.HARD.BLADE
11	134149		"BLADE.42"" MULCHER"
12	129895		BEARING.BALL
13	137645		SUB= 137646
14	128774		HSG ASM MANDREL
15	110485X		BEARING
16	140329		STRIPPER RND MWR
17	72110610		BOLT RDHD 3/8-16
18	72140505		BOLT
19	132827		BOLT SHD 5/16-18
20	136888		SUB= 918136888
21	STD541431		NUT
22	134753		STIFFENER BRKT
23	131267		DEFLECTOR BRKT
24	105304X		CAP-SLEEVE LT
25	123713X		SPRING TORSION
26	110452X		NUT PUSH M
27	130968		DEFLECTOR.SHIELD
28	19111016		WASHER
29	131491		HINGE ROD
30	138776		SUB= 157722
31	129963		WASHER
32	129861		SUB= 153535
33	137266		SUB= 139729
34	STD533717		BOLT
35	133835		XMAS TREE FASTNER
36	131494		FLAT IDLER PULLEY
37	19131316		WASHER
40	STD541437		NUT
41	133551		PIVOT ROD
43	140083		ROD CLUTCH W/NIBS
44	140088		GUARD MAND LH BLK
45	STD624003		RETAINER
46	137729		SCREW. 1/4-20X5/8
48	133944		HARD SMALL WASHER
49	133940		SUB= 151785
50	131340		SHOULDER BOLT
51	STD541410		LOCKNUT
52	139888		BOLT.SHLD.5/16-18
53	131845		BRAKE PAD ARM ASM
54	133943		HARDENED WASHER
55	140084		SUB= 151785
56	122052X		SPACER RETAINER
58	140086		SPRING TORSN BRAK
59	141043		GUARD IDLER TUV
67	106932X		KNOB T(3/8 HOLE)
68	144200		BELT.V.T-PATH
71	142427		ROD CLUTCH 38/42
72	131870		RETURN SPRING
73	127847		CLUTCH ARM SECOND
74	121748X		WASHER
75	12000029		RING

Ref #	Part Number	Qty	Description
75	12000029		RING
76	128903		SHOULDER BOLT
77	127845		SPRING KEEPER
78	140334		SUB= 154810
79	127498		BUSHING
80	128759		SUB= 918128759
81	73350600		NUT
82	142028		TRUNION ADJ
83	120958X		WASHER
84	144394		SUB= 156084
85	72140620		BOLT
92	STD541437		NUT
101	136420		"COVER.MULCH.42""
102	71161010		SCREW
103	19061216		WASHER #10
104	STD551110		WASHER, LOCK
105	130758		SUB= 160793
106	2029J		WELDNUT
111	140353		SUB= 155197
112	132262		SUB= 155198
113	17490512		SCREW
114	73510500		NUT
115	72110504		SUB= 872110504
116	137644		BOLT.SHOULDER
117	133957		WHEEL GAGE DONUT
118	73930600		LOCKNUT
119	19121414		WASHER
121	143723		BRACKET.EXTRD.GWL
	130794		MANDREL ASM
	145411		SUB= 164963